Operating manual

(Rel. 1.1)

Parrot

1x8 BROADCAST DISTRIBUTION AMPLIFIER



Via Caduti Di Sabbiuno 6/F • 40011 Anzola Emilia • Bologna • Italy ☎ +39 051 736555 • Fax. +39 051 736170
e-mail: info@axeltechnology.com • web site: www.axeltechnology.com

1 TABLE OF CONTENTS

1	TABLE OF CONTENTS	3
2	INTRODUCTION	4
3	SAFETY WARNINGS	5
3.1	AC MAINS VOLTAGE SETTING (220 V / 115 V)	6
3.2	RACK MOUNTING THE UNIT	6
3.3	REMOVING THE TOP COVER	7
3.4	GROUNDING	7
4	EQUIPMENT DESCRIPTION	8
4.1	FRONT PANEL	8
4.2	REAR PANEL	9
5	CONNECTIONS AND SETTINGS	10
5.1	AUDIO INPUT	10
5.2	INPUT IMPEDANCE	10
5.3	MONO / STEREO INPUT MODE	11
5.4	OSCILLATOR ADJUSTMENT	11
5.5	AUDIO OUTPUTS	12
5.6	MONO / STEREO OUTPUT MODE	12
6	BLOCK DIAGRAM	13
7	TECHNICAL SPECIFICATIONS	14
8	WARRANTY	14

2 INTRODUCTION

The Parrot is a high performance audio distribution amplifier with one stereo input and eight stereo outputs. It has many applications including tv and radio studios; editing rooms or where multiple loads (transmitters, amplifiers, recorders, etc) must be fed from a single audio source.

The Parrot features both XLR balanced and PinRca outputs for an easier connection to either professional or consumer equipment. The outputs are individually buffered so that a short circuit occurring on one pair of connectors (either XLR or Pin) will not affect the others. Audio input is always via XLRs.

Using internal jumper settings, the Parrot can be easily re-configured also as a 1x16 distributor for mono source signals. Alternatively, given a stereo input, the Parrot can output both mono or stereo signals, depending on the individual setting of each output pair.

Each balanced output stage incorporates high-current line drivers capable to always deliver optimal signals to a number of locations even down long cable runs and with low load impedance.

Expressly designed for broadcast applications, Parrot features an hardware bypass (via relay) which connects the Input pair to the Output 1 XLRs in case of AC power failure or whenever the unit is unintentionally turned off. This prevents the transmission chain from any audio interruption.

The electronically balanced stereo input features individual left/right level controls with two bi-color LEDs enabling quick recognition of input status (no audio, audio ranging between 0 and + 6 dBm or audio higher than + 6 dBm). Each of the four output groups also incorporate left/right level controls via recessed trimmers on the front panel.

The Parrot is very easy to install and to operate. A '0 dB gain' mode can be selected for each output channel via front panel accessible slide switches. For fine calibration of the outputs, the source signal can be replaced by an internal 1kHz / 0 dB oscillator.

3 SAFETY WARNINGS

A correct installation and an optimum level setting are crucial for a good operating and the exploitation of all the equipment capabilities. Please pay attention to the following notes:



The installation and servicing instructions in this manual are for use by qualified personnel only.

This symbol alerts you to the presence of dangerous voltage inside the closure – voltage which may be sufficient to constitute a risk of shock. Do not perform any servicing other than that contained in the operating instructions. Refer all servicing to qualified personnel

- **Read All Instructions.** All safety and operating instructions must be read before operating the product. They also must be retained for future reference, as it contains a number of useful hints for determining the best combination of equipment settings for Yr particular application.
- **Heed All Warnings.** All warnings on the product and those listed in the operating instructions must be adhered to.
- **Heat.** This product must be situated away from any heat sources such as radiators or other products (including power amplifiers or transmitters) that produce heat.
- **Power Sources.** This product must be operated from the type of power source indicated on the marking label and in the installation instructions. If you are not sure of the type of power supplied to your facility, consult your local power company. Make sure the AC main voltage corresponds to that indicated in the technical specifications. If a different voltage (ex. 110/115 VAC) is available, open the equipment closure and set the voltage switch on the main supply circuit, located behind the VDE socket.
- **Power Cord Protection.** Power supply cords must be routed so that they are not likely to be walked on nor pinched by items placed upon or against them. Pay particular attention to the cords at AC wall plugs and convenience receptacles, and at the point where the cord plugs into the product.
- **Lightning.** For added protection for this product during a lightning storm, or when it is left unattended and unused for long periods of time, unplug it from the AC wall outlet and the audio connections. This will prevent damage to the product due to lightning and power line surges.
- **Installation.** The installation must be carried on by skilled technicians.
- **Cabling.** Using high quality wires, well protected, and balanced connections is highly recommended. Make sure the cable integrity.
- **Equipment design.** This manual images could differ a bit from the equipment actual design.

3.1 AC MAINS VOLTAGE SETTING (220 V / 115 V)



BE SURE THAT THE UNIT IS SET TO THE CORRECT MAINS/LINE VOLTAGE FOR YOUR COUNTRY BEFORE PLUGGING IT INTO THE WALL OUTLET.

The actual Mains voltage is indicated on the silver label stuck on the right side of the Parrot closure.

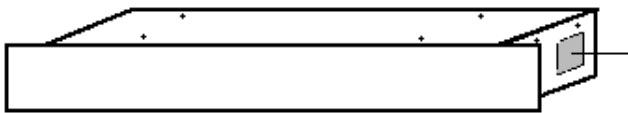

If, for some reason, the unit is to be operated at a mains input voltage which is different to that as supplied, you need to open the top cover and set properly the **voltage change-over switch** which is located inside, close to the transformer (on the right hand). You also need to replace the AC main fuse (for 220/230 V AC the fuse is rated at 630mA T; for 110 V AC voltage it is rated at 1 A T)

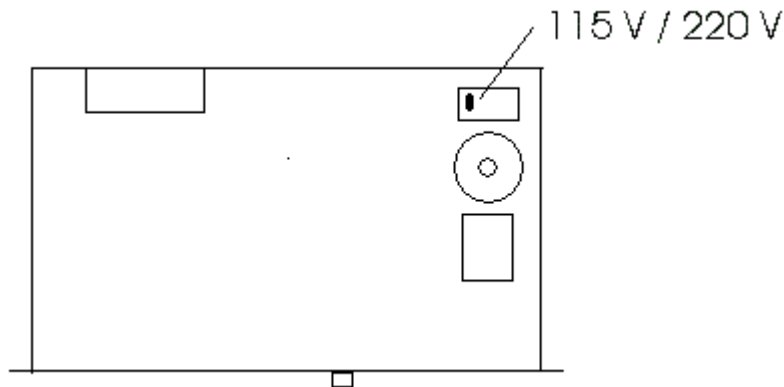

3.2 RACK MOUNTING THE UNIT

To mount the unit in a standard 483 mm (19-inch) audio equipment rack, slide the equipment into the rack and secure it with crosshead screws, as shown in the figure. Use all four screws.

Ventilation. Slots and openings in the product are provided for ventilation. They ensure reliable operation of the product, keeping it from overheating. These openings must not be blocked nor covered during operation.

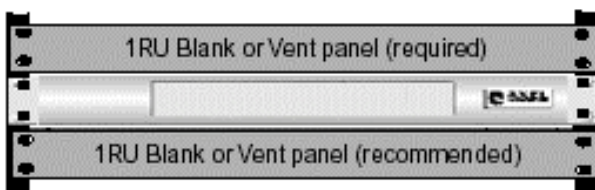

You must leave at a minimum one rack unit of empty space above the Parrot to enhance ventilation and to get a longer equipment life.

Install a 1U vented or blind panel to fill this space. It is recommended that another 1RU blank panel be installed below the unit for the same reason.

There should be a good ground connection between the rack and the Parrot chassis

3.3 REMOVING THE TOP COVER

To change any jumpers or set the voltage changeover you must remove the top cover of the unit to access the main boards. Remove all 6 screws holding the cover in place, then lift it off. Use care when working inside the unit.

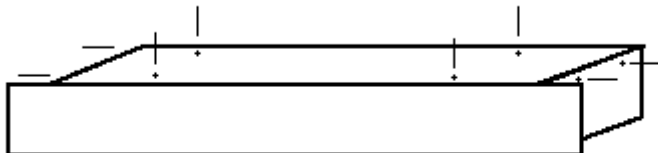

Uninsulated dangerous voltage are inside the enclosure, voltage that may be sufficient to constitute a risk of shock.

Always disconnect to AC Mains before removing the top cover

3.4 GROUNDING

- **THIS EQUIPMENT MUST BE EARTHED.**

The chassis is always connected to mains earth to ensure your safety: check your mains wiring and earthing before switching on.

NOTE: inside the unit, audio 0V is always DC decoupled from mains earth (ground lifted) to avoid ground loop problems.

4 EQUIPMENT DESCRIPTION

4.1 FRONT PANEL

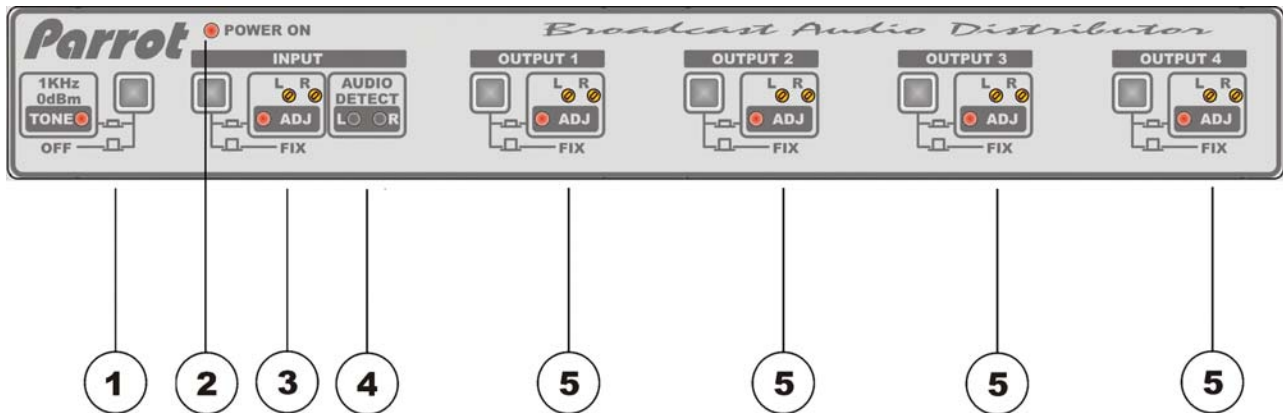

- 1 **TEST TONE OSCILLATOR SWITCH**

The Parrot contains an oscillator that can produce a sine wave tone at a 1 KHz / 0 dBm for system setup and alignment. When **TONE** button is pressed (LED glowing), the sinusoidal TONE is placed on all the outputs (Out 1, Out 2, Out 3 and Out 4) by replacing the existing source signal. When released, the audio distributor returns to its previous state (normal operation). The oscillator frequency and the injection levels can be easily adjusted via internal trimmers (see Section 5.4)
- 2 **'POWER ON' LED INDICATOR**

It displays the power supply presence. If the LED is not lit, confirm that the main power source is active, that the main switch is on and that the connector on the cord is securely mated with the plug on the back panel.
- 3 **INPUT LEVEL CONTROLS**

These controls should be used to set the optimal input gain for both Left and Right signals. A recessed switch enables the Gain adjustment.

 - With the switch released, the input gain factor is **fixed** at 0 dB (unity gain factor) and can not be altered
 - With the switch pressed (LED glowing), the gain factor can be adjusted via the separated L & R trimmers. Adjustment in the range +/- 20 dB is possible.
- 4 **AUDIO DETECT**

Bi-color LEDs enabling quick recognition of input audio level.

<i>LED OFF</i>	<i>Audio level below 0 dBm</i>
<i>LED turned GREEN</i>	<i>Audio level ranging between 0 and + 6 dBm</i>
<i>LED turned RED</i>	<i>Audio level higher than + 6 dBm</i>

- 5 **OUTPUT LEVEL CONTROLS**

These controls should be used to set the optimal level for both Left and Right signals on each Output group. A recessed switch enables the Gain adjustment.

 - With the switch released, the output gain factor is **fixed** at 0 dB (unity gain factor) and can not be altered.
 - With the switch pressed (LED glowing), the output gain may be varied from - 20 dB to 20 dB by adjusting the pre-set trimmers, which are accessible through the holes in the front panel

Ref. also to the Parrot's Block Diagram (Chapter 6).

4.2 REAR PANEL

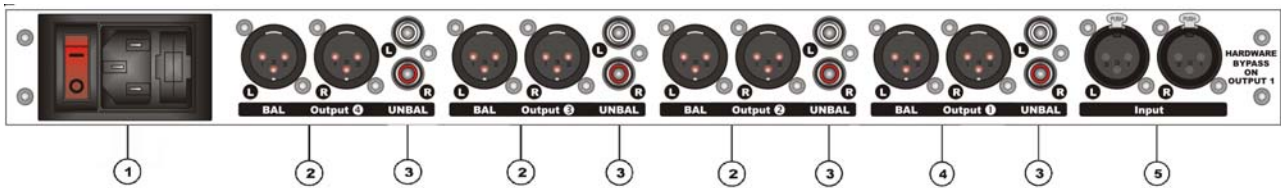

- 1 **ON/OFF Switch:** main ON/OFF switch, the LED inside switches on/off accordingly. The power supply socket (use the cord provided) has a built-in fuse drawer containing the power fuse and a spare, both of the same value: for 220/230 V AC the fuse is rated at 630mA T; for 110 V AC voltage it is rated at 1 A T.
- 2 XLR outputs # 2, 3 and 4. They are electronically balanced. Each output is individually buffered so that a short circuit on one output will not affect the others. The output level on each output is adjusted by the associated trimmers on the front panel (see Front Panel description). Stereo / Mono operation can be set via Jumpers placed inside, on the rear board.
- 3 A pair of PinRca connectors provide an unbalanced, stereo repetition of the output signal appearing at the XLR connectors. Each group (#1, #2,#3 and #4) of XLRs + PinRca connectors is separately level-adjusted via the associated Gain controls on the front panel. PinRca outputs are individually buffered so that a short circuit on one output will not affect the others.
- 4 XLR output # 1. It is electronically balanced. Each output is individually buffered so that a short circuit on one output will not affect the others. The level is adjusted by the associated trimmers on the front panel (see Front Panel description). An hardware bypass (via relay) connects the Input pair to the Output 1 XLRs in case of AC power failure or whenever the unit is unintentionally turned off. This prevents the transmission chain from any audio interruption.
- 5 XLR input pair (electronically balanced). They may also be used in an unbalanced configuration. An hardware bypass (via relay) connects the Input pair to the Output 1 XLRs in case of AC power failure or whenever the unit is unintentionally turned off. This prevents the transmission chain from any audio interruption. Stereo / Mono operation can be set via Jumper. The Jumper is placed inside, on the front board.

5 CONNECTIONS AND SETTINGS

We suggest to use high quality wires, well protected, and balanced connections to avoid external EMD. If **ground loop** problems are encountered, never disconnect the mains earth, but instead, try disconnecting the signal screen on one end of each of the cables connecting the outputs of the Parrot to the loads. If such measures are necessary, balanced operation is recommended.

5.1 AUDIO INPUT

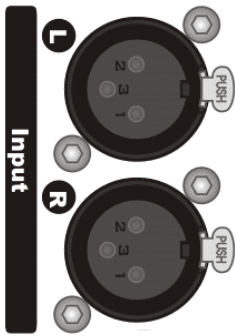

The equipment features electronically balanced XLR female inputs (line level).

- Pin 1 Gnd
- Pin 2 Signal
- Pin 3 Return

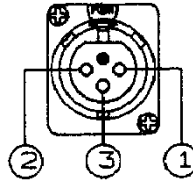

If no balanced connection is possible, please connect the cold pole (Pin 3) to the ground (Pin 1). Factory preset input impedance is 10 kΩ. Input impedance of 600 Ω is also available, simply setting jumpers on the rear I/O board (see next Section).

5.2 INPUT IMPEDANCE

At the delivery, input Impedance is set at 10 Kohm. The impedance may be set to 600 Ohm by moving the jumpers located on the rear board (J2 and J3) close to the XLR input connectors, as shown in the following figure:

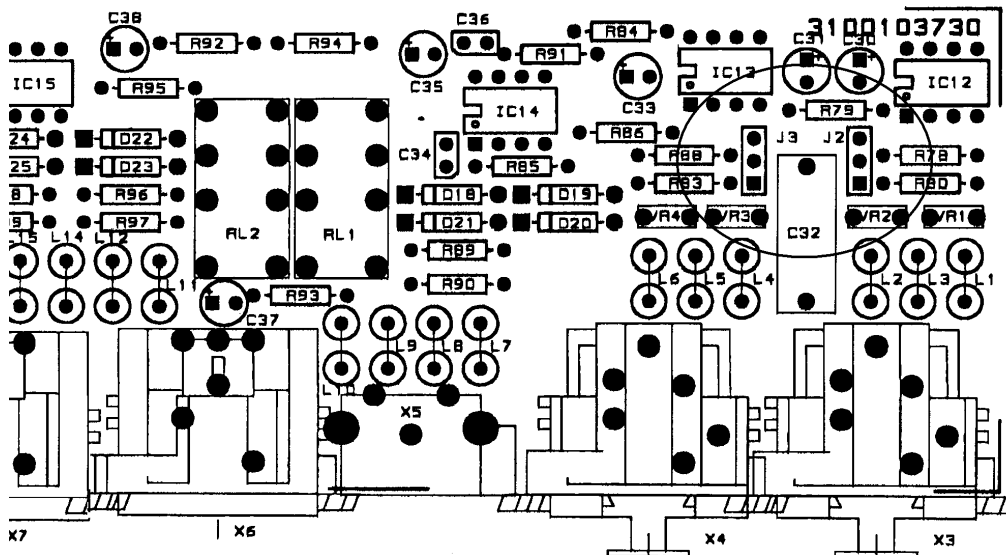

J3
 Input LEFT
 impedance = 10 KΩ
 (factory preset)

J3
 Input LEFT
 impedance = 600 Ω

J2
 Input RIGHT
 impedance = 10 KΩ
 (factory preset)

J2
 Input LEFT
 impedance = 600 Ω

5.3 MONO / STEREO INPUT MODE

Using the **Stereo** input setting, both Left and Right signals are directed to their respective output paths. In the **Mono** input configuration the **Left input signal is replicated on the Right internal bus**, while the Right input connector is disconnected. Thus, provide the LEFT channel only. See Block Diagram - Chapter 6. The Mono / Stereo input mode may be set by moving the jumper **J18** located on the front board **behind the INPUT FIX / ADJ switcher**, as shown in the following figure:

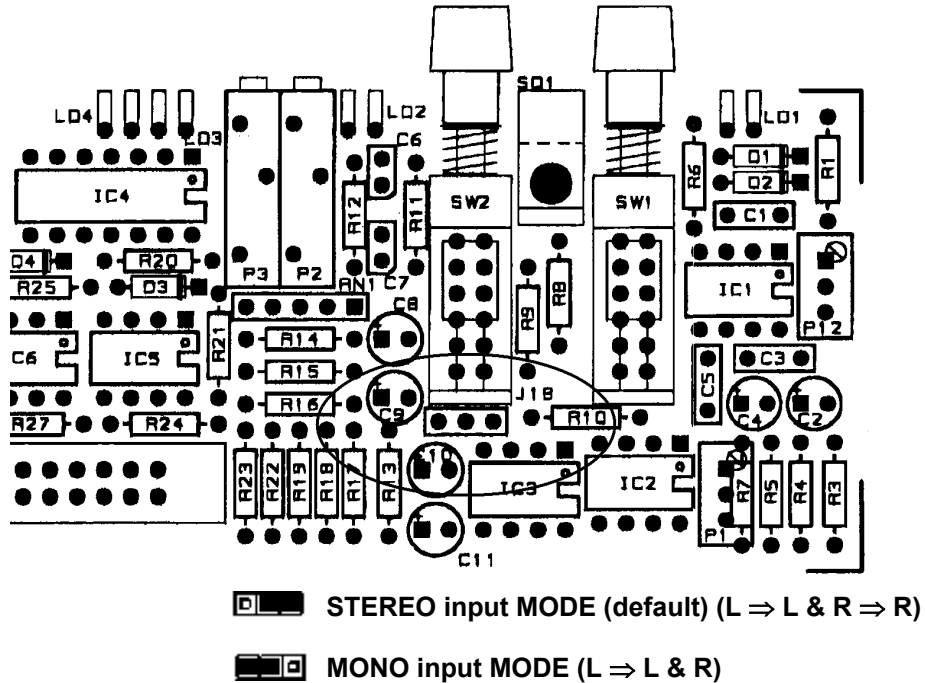

5.4 OSCILLATOR ADJUSTMENT

The oscillator frequency and the injection levels can be easily adjusted via trimmers P12 and P11, placed on the Fron Board, close to the OSCILLATOR front switcher.

P12 regulates the frequency, while P11 regulates the level. Factory preset is 1 kHz, 0 dBm.

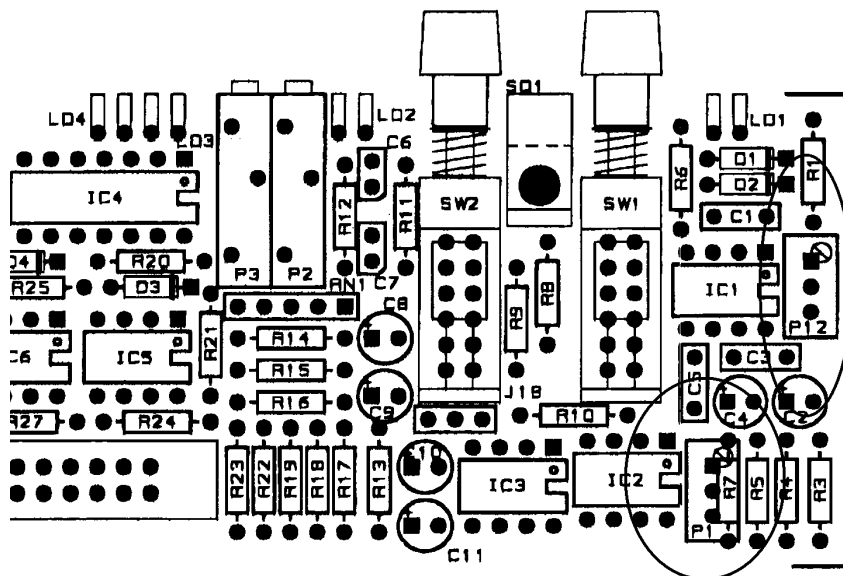

5.5 AUDIO OUTPUTS

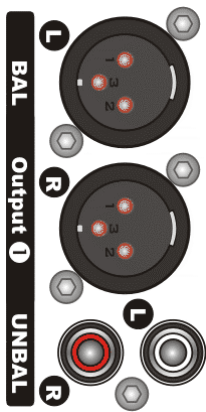

The equipment features balanced XLR and unbalanced PinRca analog outputs driven by high-quality buffers and capable of withstanding even low-impedance loads (600Ω), with levels of up to +20 dBu. In case of unbalanced connections, connect the cold pole (Pin 3) to the ground (Pin 1) or use the PinRca unbalanced outputs.

Pin 1 Gnd
Pin 2 Signal
Pin 3 Return

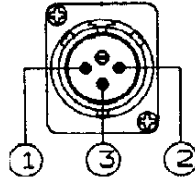

An hardware bypass (via relay) connects the Input pair to the Output 1 XLRs in case of AC power failure or whenever the unit is unintentionally turned off. This prevents the transmission chain from any audio interruption.

5.6 MONO / STEREO OUTPUT MODE

Left and Right signals can be summed at the output stage of each output group. Independent mono/stereo settings are provided for each group (i.e. pair of PinRca and XLR connectors). When set in MONO mode, each output connector provides (L + R) / 2 signal (ref to the Block Diagram).

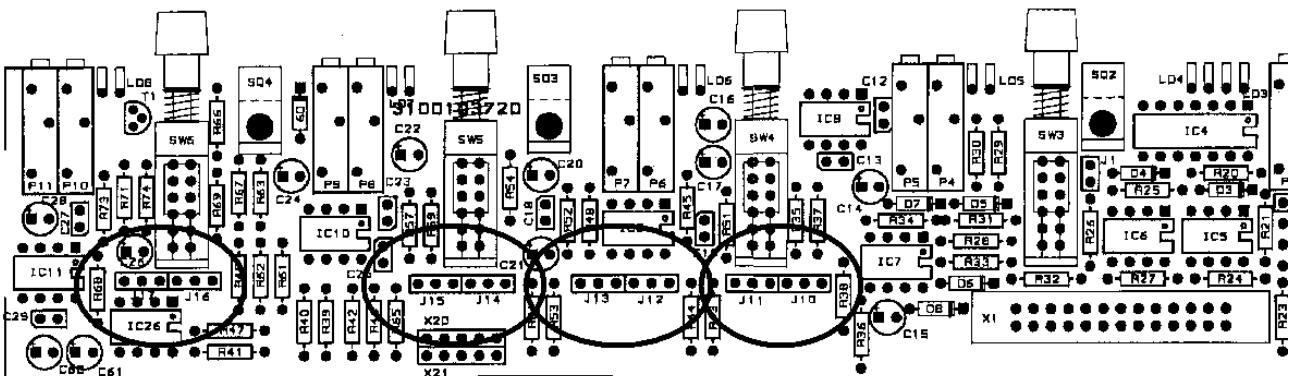

RIGHT CHANNEL

LEFT CHANNEL

OUTPUT	RIGHT CHANNEL	LEFT CHANNEL
OUTPUT 1	J10 STEREO MODE	J11 STEREO MODE
	J10 MONO MODE	J11 MONO MODE
OUTPUT 2	J12 STEREO MODE	J13 STEREO MODE
	J12 MONO MODE	J13 MONO MODE
OUTPUT 3	J14 STEREO MODE	J15 STEREO MODE
	J14 MONO MODE	J15 MONO MODE
OUTPUT 4	J16 STEREO MODE	J17 STEREO MODE
	J16 MONO MODE	J17 MONO MODE

6 BLOCK DIAGRAM

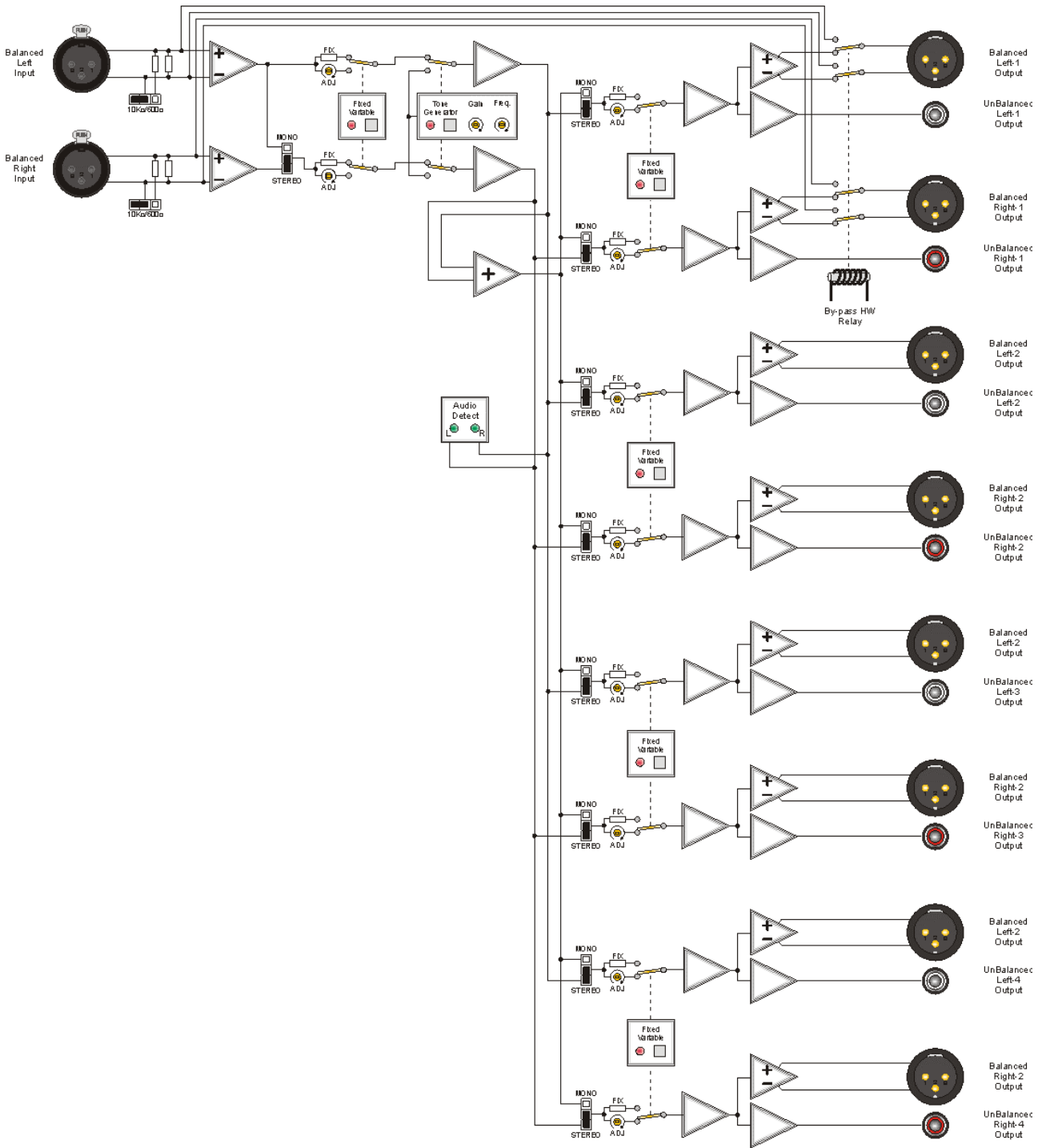

7 TECHNICAL SPECIFICATIONS

AUDIO INPUT	
Number of inputs	1, el. balanced
Connectors	XLR
Input impedance	600 Ω / 10K Ω (selectable)
Nominal Input level	0 dBm
Max input level	+ 20 dBm
Input Mode	Mono / Stereo (selectable)
CMRR	> 80 dB typically at 1 kHz

GENERAL DATA	
Power Supply	220 / 110V +/- 10 % 10VA
Dimension	434x351x44mm (1 rack unit)
Weight	around 4 Kg

AUDIO OUTPUT	
Number of indep. output groups	4
Connectors	8 XLR (el. bal) + 8 PinRca
Nominal output level	0 dBm
Max output level	+20 dBm (with 600 Ohm load)
Output impedance	50 Ω
Frequency Response	20Hz to 100kHz +/- 0.1dB
Overall Gain Range	42 dB
THD +Noise	0.005% @ 1kHz
Output Mode	Mono / Stereo (selectable for each group)
Crosstalk	< -80 dB @ 10kHz, 0 dBm out
Noise	< - 80 dBm (DIN Audio)
Reference output tone	1 kHz, 0 dBm

8 WARRANTY

The manufacturer offers a 1-year ex works warranty.

Do not open the equipment. The warranty shall be voided if any of the warranty seals are broken.

The manufacturer shall not be liable for damage of any kind deriving from or in relation to incorrect use of the product.