

Operating Manual

(Rel. 1.3)

Merlin

Broadcast Audio Changeover

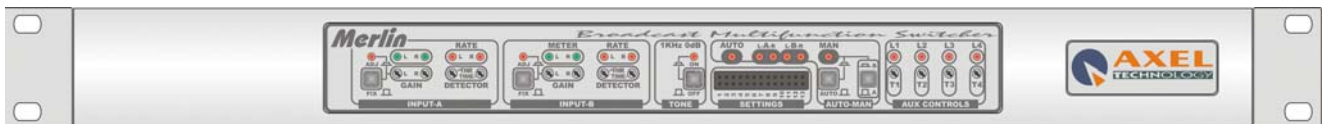

Via Caduti Di Sabbiano 6/F • 40011 Anzola Emilia • Bologna • Italy ☎ +39 051 736555 • Fax. +39 051 736170
e-mail: info@axeltechnology.com • web site: www.axeltechnology.com

1 TABLE OF CONTENTS

1	TABLE OF CONTENTS.....	3
2	INTRODUCTION.....	5
2.1	MERLIN OPTIONAL MODULES	6
3	SAFETY WARNINGS	7
4	CONNECTING MAINS POWER.....	8
4.1	EARTHING	8
5	INSTALLATION.....	10
5.1	UNPACKING AND INSPECTION	10
5.2	AC MAINS VOLTAGE SETTING (220 V / 115 V).....	10
5.3	RACK MOUNTING THE UNIT.....	11
5.4	REMOVING THE TOP COVER	12
5.5	GROUNDING	12
6	GENERAL DESCRIPTION	13
6.1	FRONT PANEL.....	13
6.2	REAR PANEL	15
7	CONFIGURATIONS.....	17
7.1	INPUT SWITCHING MODES (JUMPER SETTING)	17
7.2	SWITCHING-RELATED AUDIO LEVELS	19
7.2.1	'SILENCE' THRESHOLD	19
7.3	INPUT SWITCH TIMING	19
7.3.1	'SILENCE' TIME.....	19
7.3.2	RECOVERY TIME	21
7.4	MONO / STEREO INPUT MODE.....	22
7.5	INPUT B PRE-EMPHASYS	23
7.6	19 KHz PILOT TONE ACTIVATION.....	24
7.7	INJECTION OF AN EXTERNAL SOURCE.....	25
7.8	SWITCHING BETWEEN COAXIAL SOURCES (VIDEO, MPX, ETC)	27
8	ADJUSTEMENTS	28
8.1	REFERENCE TONE LEVEL AND FREQUENCY	28
8.2	PILOT TONE FREQUENCY	29
8.3	PILOT TONE INJECTION LEVEL ON B-RIGHT & B-LEFT CHANNELS	30
8.4	LEVEL OF INJECTION OF AN EXTERNAL SIGNAL ON L&R OUTPUT CHANNELS.....	31
9	AUDIO AND REMOTE INTERFACE DESCRIPTION.....	32
9.1	AUDIO CONNECTIONS.....	32
9.1.1	INPUTS.....	32
9.1.2	INPUT IMPEDANCE SETTING.....	32
9.1.3	PIN RCA CONNECTOR ASSIGNMENT	33
9.1.4	OUTPUT	34
9.2	'OPTO' INTERFACE.....	35
9.3	SPECIAL SWITCHING FEATURES	37
9.4	'RELAY' INTERFACE (OPTIONAL)	38
9.4.1	Relay 1, Relay 2 and Relay 3 assignment.....	39
9.4.2	Relay 1 assignment to Dc POWER failure.....	42

Merlin - TABLE OF CONTENTS

9.4.3	<i>Momentary or Latched Relay setting</i>	43
10	VCA OPTION	44
10.1	CROSSFADE MODE.....	45
10.2	AUTOFADER MODE.....	45
11	BLOCK DIAGRAM	46
12	TECHNICAL SPECIFICATIONS	47

2 INTRODUCTION

The Merlin is designed to provide sophisticated changeover of audio signals, such as stereo pairs and even FM multiplex and video composite signals. Incoming signals are constantly monitored and if a fault is detected on the signal applied to a set Input, it will switch to a stand-by source (such as a CD), in order to keep transmissions running.

The Merlin fulfils the needs of every radio station for manual or automatic (emergency) switching between different audio sources. Multiple switching mode are provided (switch on stand-by input only when active, switch and stay on the second input, etc). Up to 7 internal relays can be associated to the audio switching for further alarm signalling, external signal routing, starting CD players etc.

Using internal and front settings, the Merlin can be easily re-configured for a variety of applications, either in the radio or in the video field. The delay times before switching and before returning to the normal state (recovery) are easily set by trimmers and jumpers.

The Merlin features both XLR balanced and PinRca audio inputs for an easier connection to either professional or consumer equipment. Each pair of PinRca inputs can be also reverted to unbalanced 'foldback' outputs. The balanced XLR output stage incorporates high-current line drivers capable to always deliver optimal signals even down long cable runs and with low load impedance. Bnc, 75 Ohm terminated connectors are available for video and Mpx signals.

Expressly designed for broadcast applications, Merlin features an hardware bypass (via relay) which connects the Input 1 pair (and the Coaxial Input 1 as well) to the Output (both XLRs and Bnc) in case of AC power failure or whenever the unit is unintentionally turned off. This prevents the transmission chain from any audio interruption.

The electronically balanced stereo inputs feature individual left / right gain controls with two bi-color LEDs enabling quick recognition of input status (no audio, audio ranging between - 6 and + 3 dBm or audio higher than + 3 dBm dB).

The Merlin is very easy to install and to operate. A '0 dB gain' mode can be selected for each output channel via front panel accessible slide switches. For fine calibration of the outputs, the source signal can be replaced by an internal 1kHz / 0 dB oscillator.

The rear panel includes a remote control / monitoring socket (optoinsulated) which may be used to connect external warning circuit. The contacts are open during normal operation and close during failure. These relays may be used to activate an external alarm in the event of a failure - even in case of missing power. An external control may be also applied to force the switching from remote.

The Merlin can be equipped with plug-in, optional modules which greatly improve its application fields: MPX decoder, Video monitor, Serial monitor and Crossfade module.

Merlin highlights:

- **Audio changeover 2 inputs /1 output**
- **Double Audio Detector fully user-settable**
- **Fully configurable for a range of applications**
- **Wide remote control capabilities**
- **Complete control of stereo audio, FM multiplex / Video composite source failures**
- **Hardware Bypass in case of AC Main failure**
- **Internal 1kHz / 0 dB oscillator**
- **Automatic / manual operation**

2.1 MERLIN OPTIONAL MODULES

MPX	An MPX decoder is applied to the incoming MPX signals, resuming the Left and Right audio channels from the composite signal and routing them to the Input A for regular detection (see above). A pilot detector is also provided (which can be disabled), switching to the backup signal if pilot is lost.
SERIAL	A decoder is provided which constantly monitors serial RS 232 connection activity and provides contact closures (f.i. a RESET command) in case of connection freezing lasting more than a pre-set time. A dedicated software application running on Windows platforms comes with the unit.
VCA	It allows cross-fades between sources, with fully configurable rising / fading times and levels.
VIDEO	A special stage watches after video sync switching to the backup signal if it is lost
RELAY	Set of 5 internal relays

3 SAFETY WARNINGS

A correct installation and an optimum level setting are crucial for a good operating and the exploitation of all the equipment capabilities. Please pay attention to the following notes:



The installation and servicing instructions in this manual are for use by qualified personnel only.

This symbol alerts you to the presence of dangerous voltage inside the closure – voltage which may be sufficient to constitute a risk of shock. Do not perform any servicing other than that contained in the operating instructions. Refer all servicing to qualified personnel

- **Read All Instructions.** All safety and operating instructions must be read before operating the product. They also must be retained for future reference, as it contains a number of useful hints for determining the best combination of equipment settings for Yr particular application.
- **Heed All Warnings.** All warnings on the product and those listed in the operating instructions must be adhered to.
- **Heat.** This product must be situated away from any heat sources such as radiators or other products (including power amplifiers or transmitters) that produce heat.
- **Power Sources.** This product must be operated from the type of power source indicated on the marking label and in the installation instructions. If you are not sure of the type of power supplied to your facility, consult your local power company. Make sure the AC main voltage corresponds to that indicated in the technical specifications. If a different voltage (ex. 110/115 VAC) is available, open the equipment closure and set the voltage switch on the main supply circuit, located behind the AC socket.
- **Power Cord Protection.** Power supply cords must be routed so that they are not likely to be walked on nor pinched by items placed upon or against them. Pay particular attention to the cords at AC wall plugs and convenience receptacles, and at the point where the cord plugs into the product.
- **Lightning.** For added protection for this product during a lightning storm, or when it is left unattended and unused for long periods of time, unplug it from the AC wall outlet and the audio connections. This will prevent damage to the product due to lightning and power line surges.
- **Installation.** Configuration and installation should only be carried out by a competent installation engineer.
- **Cabling.** Using high quality wires, well protected. Make sure the cable integrity.
- **Equipment design.** This manual images could differ a bit from the equipment actual design.

4 CONNECTING MAINS POWER

WARNING: Make sure the power supply voltage is correctly set to match your local mains voltage. Refer to the Power Supply Chapter in this operating manual. Before connecting the unit to mains power, determine the actual mains voltage and confirm that it has been configured correctly. As could be expected, an incorrect mains configuration could seriously damage the unit. Should it be necessary to change the unit's operating voltage refer to the Power Supply Chapter in this operating manual.

The Power Supply unit accepts mains voltages 100 and 230V AC by setting the position of an internal switch..

4.1 EARTHING

WARNING: THIS EQUIPMENT MUST BE EARTHED

The connection to earth (ground) in an audio system is crucial for two reasons:

1. SAFETY
2. AUDIO PERFORMANCE

For safety it is important that all equipment earths are connected to mains earth so that exposed metal parts are prevented from carrying high voltage which can injure the operator.

The same earth is also used to shield audio cables from external interference such as the hum fields associated with power transformers, lighting dimmer buzz, and computer radiation. Problems arise when the signal sees more than one path to mains earth. An earth loop results causing current to flow between the different earth paths. This condition is usually detected as a mains frequency audible hum or buzz. To ensure safe and trouble-free operation we recommend the following:

Use a clean mains outlet for the audio system: Be sure to use a 'clean' power outlet, i.e. one that is fed directly from the mains, including earth. "Polluted" mains are caused by changing currents on the outlets, such as air-conditioners, coffee machines, fridges, computers, dimmer packs etc. DO NOT connect any of these types of items to the Merlin main power outlet.

Use star point earthing: It is best to install a 'star point' system where the individual earths to the equipment racks and equipment areas are separately run from a solid central reference earth point.

Have your mains system checked by a qualified electrician.

Do not remove the earth connection from the Merlin mains plug: The Merlin chassis is connected to mains earth through the power cable to ensure your safety. If problems are encountered with earth loops disconnect the audio cable screens at one end, usually at the destination. Equipment such as CD players do not have a mains ground connection. In this case the shielding can be connected on both sides of the connection - a ground loop will not occur. Try to choose a CD player with metal housing.

Avoid induced interference: To prevent interference pickup keep audio cables away from mains power units, cables and distribution boards, motors, lighting and computer cables and equipment, and any other heavy duty electrical equipment. Where this cannot be avoided cross the audio and 'dirty' equipment cables at right angles to minimise interference.

Merlin - CONNECTING MAINS POWER

Use balanced connections where possible as these provide further immunity by cancelling out interference that may be picked up on long cable runs. To connect an unbalanced source to a Merlin input (balanced), link the cold input (XLR pin 3 or jack ring) to 0V earth (XLR pin 1 or jack ground) at the Merlin side. To connect the Merlin output (balanced) to an unbalanced destination, link the cold output to 0V earth at the changeover side.

Use good quality cables and connectors and check for correct wiring and reliable solder joints. Allow sufficient cable loop to prevent damage through stretching.

If you are not sure ... Contact your Axel Technology agent or Axel Technology technical support (tech@axeltechnology.com) for advice.

5 INSTALLATION

5.1 UNPACKING AND INSPECTION

If you note obvious physical damage, contact the carrier immediately to make a damage claim. Packed with the unit are:

1 Operating Manual
1 Line Cord



Save all packing materials! If you should ever have to ship the unit (e.g., for servicing), it is best to ship it in the original carton with its packing materials because both the carton and packing material have been carefully designed to protect the unit.

Under normal conditions no user maintenance or calibration are required. Internal links and preset controls may be set to configure the unit during installation. **Any service work required should be carried out by qualified service personnel only.**

We are able to offer further product support through our worldwide network of approved dealers and service agents.

To help us provide the most efficient service please would you keep a record of **the unit serial number**, and date and place of purchase to be quoted in any communication regarding this product.

5.2 AC MAINS VOLTAGE SETTING (220 V / 115 V)



BE SURE THAT THE UNIT IS SET TO THE CORRECT MAINS/LINE VOLTAGE FOR YOUR COUNTRY BEFORE PLUGGING IT INTO THE WALL OUTLET !

The actual Mains voltage is indicated on the label stuck on the equipment closure.

If, for some reason, the unit is to be operated at a mains input voltage which is different to that as supplied, you need to open the top cover and set properly the **voltage change-over switch** which is located inside, close to the transformer (on the right hand). You also need to replace the AC main fuse (rated at 500mA T for both AC tensions)

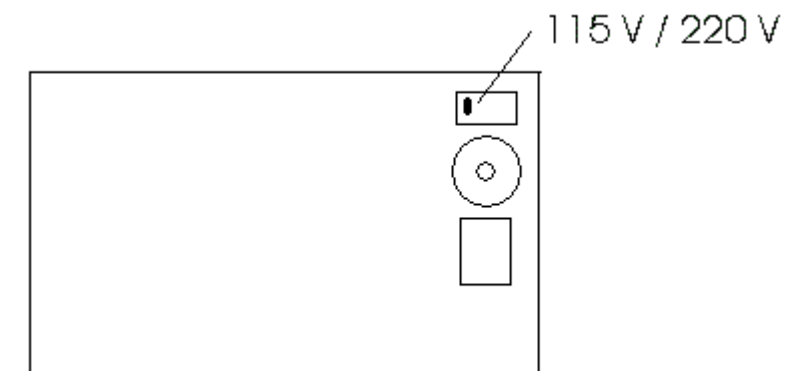

The power supply socket has an integral fuse drawer containing the AC power fuse and a spare, both of the same value. For 220 / 230 V AC and 110 / 115 V AC tensions, the fuse is rated at 500mA T.



CAUTION: TO REDUCE THE RISK OF ELECTRICAL SHOCK, DO NOT REMOVE THE VOLTAGE CHANGEOVER COVER. NO USER SERVICEABLE PARTS INSIDE. REFER SERVICING TO QUALIFIED SERVICE PERSONNEL.

5.3 RACK MOUNTING THE UNIT

The encoder requires one standard rack unit. Dimensions shown are case size in millimeters. Allow extra space for the rear connectors.

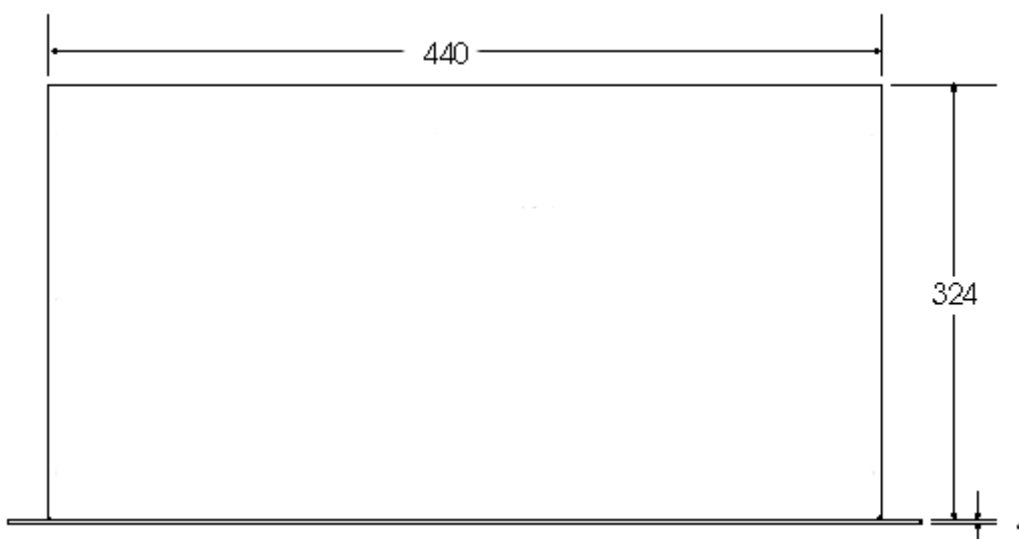
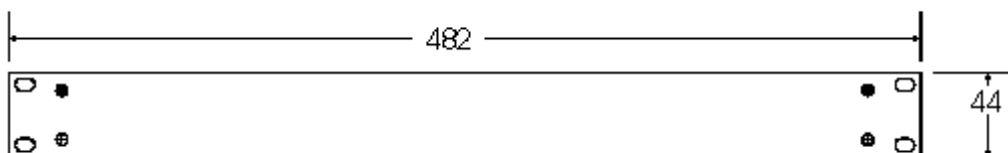

Merlin - INSTALLATION

To mount the unit in a standard 483 mm (19-inch) audio equipment rack, slide the equipment into the rack and secure it with front crosshead screws. Use all four screws.



Ventilation. Slots and openings in the product are provided for ventilation. They ensure reliable operation of the product, keeping it from overheating. These openings must not be blocked nor covered during operation. **You must leave at a minimum one rack unit of empty space above the equipment to enhance ventilation and to get a longer equipment life.**

In case of rack mounting, there should be a good ground connection between the rack and the equipment chassis — check this with an ohmmeter to verify that the resistance is less than 0.5 Ohm.

5.4 REMOVING THE TOP COVER

A unique flexibility is offered, in order to satisfy the exact requirements of each installation. This is done by setting internal jumper links and calibration trimmers which determine the operating levels and the signal routing. Jumper links are accessed by removing the top cover. Once installed the settings become tamperproof and only the software remote control is available to the user making the unit extremely easy to operate.

To change any jumpers or set the voltage changeover you must remove the top cover of the unit to access the main boards. Remove all 8 screws holding the cover in place, then lift it off. Use care when working inside the unit.

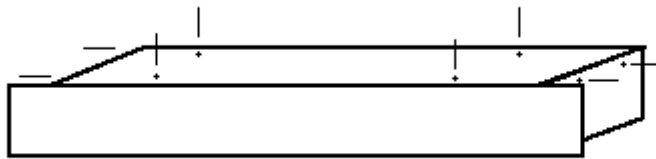

Uninsulated dangerous voltage are inside the enclosure, voltage that may be sufficient to constitute a risk of shock.
Always disconnect to AC Mains before removing the top cover

5.5 GROUNDING

- **THIS EQUIPMENT MUST BE EARTHED.**

The chassis is always connected to mains earth to ensure your safety: check your mains wiring and earthing before switching on.

6 GENERAL DESCRIPTION

6.1 FRONT PANEL

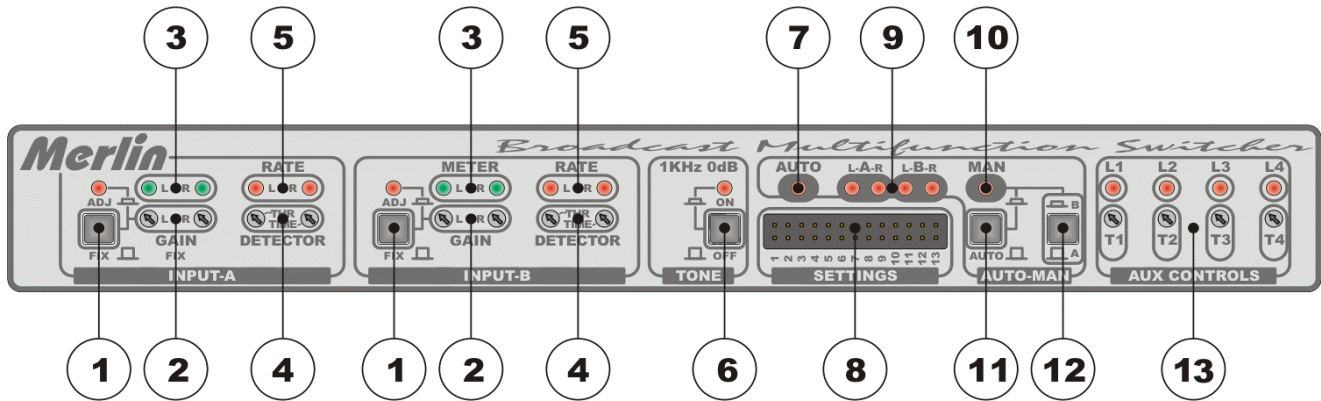

- 1 FIX / ADJ BUTTONS** It selects input source pre-amplification mode:
- FIX: gain applied to input source adjustable is unitary (0 dB) and it can not be adjusted
 - ADJ (key pressed, Led illuminated): gain applied to input source adjustable via trimmers (2)
- 2 'GAIN' TRIMMERS** Enabled only with Key (1) pressed, they adjust the input source gain:
- trimmer in the middle position: 0 dB gain
 - trimmer anti-clockwise: - 20 dB
 - trimmer clock-wise: + 20 dB
- 3 METERS** Two bicolor LEDs (Meter) indicate the current audio level after Gain trimmers accordingly to the following table:
- | | |
|------------------------------|------------------------------------------|
| <i>LED 'Off'</i> | <i>Audio level < 0 dBm</i> |
| <i>LED illuminated GREEN</i> | <i>Audio level between 0 and + 6 dBm</i> |
| <i>LED illuminated RED</i> | <i>Audio level > + 6 dBm</i> |
- 4 'DETECTOR' CONTROLS** The 'THR' Trimmer defines the 'silence' threshold level (i.e. the 'valid' minimum signal level).
- The 'TIME' Trimmer defines the time taken to react to signal failure. It is programmable via Jumpers provided in the SETTINGS Section (see § 7.1).
- 5 'RATE' LEDS** 'RATE' LEDS blinking indicates time flowing, as set by 'TIME' trimmer (see § 7.3.1)

Merlin - GENERAL DESCRIPTION

- 6 BUILT-IN OSCILLATOR** Merlin contains an oscillator designed for system setup ad alignment and generating 1 KHz / 0 dBm tone.
- When TONE button is pressed all current inputs are turned off, and the sinusoidal TONE is placed on all output connectors (Left and Right). When disabled (TONE LED off), the changeover returns to its previous state (normal operation).
- See Section 8.1
- 7 'AUTO'LED** It indicates *automatic* operating mode, accordingly to the status of button **(11)**.
- 8 JUMPER SETTINGS** 13 Jumpers are intended for easy setting of all main operating modes (see Section 7.1).
- 9 'A' and 'B' LEDS** They are associated to the currently active input (A or B): A LED glowing means 'A' input active and viceversa.
- 10 LED 'MAN'** It indicates *manual* operating mode, accordingly to the status of button **(11)**.
- 11 AUTO / MAN BUTTONS** It toggles between two Merlin operating modes:
- manual: input selection is accomplished manually, through the button **(12)**. All 'silence detector' functions are disabled.
 - automatic: input selection is driven by 'silence detector' circuit. The unit can also be remotely controlled via the 'Opto' interface (see **(2)** on the rear panel)
- 12 A / B BUTTON** Whit 'manual' mode engaged (see **(11)**), it selects the active input (A / B)
- 13 'AUX' CONTROLS** Those 4 trimmer and 4 LEDs are associated to auxiliary circuits and options.

Merlin - GENERAL DESCRIPTION

6.2 REAR PANEL

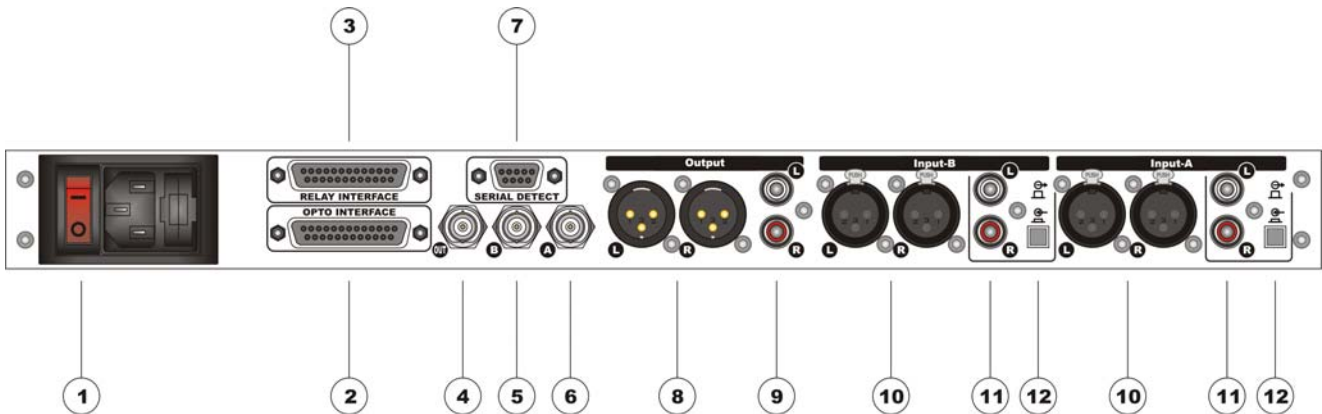

- | | | |
|----|---------------------------------------|-------------------------------------------------------------------------------------------------------------------------------------------------------------------------------------------------------------------------------------------------------------------------------------------------------------------------------------------------------------------------------------------------|
| 1 | ON/OFF main switch, AC outlet: | main ON/OFF switch, the LED inside switches on/off accordingly. The power supply socket (use the cord provided) has a built-in fuse drawer containing the power fuse and a spare, both of the same value (500 mA).

We suggest to use that value either for 220 Vac sources or 110 Vac source. |
| 2 | 'OPTO' INTERFACE | Designed for Merlin remote control. Ref to Section 9.2 |
| 3 | RELAY INTERFACE | Available as an option, it features 5 jumper-settable Relays. See § 9.4 |
| 4 | BNC OUTPUT | V. § 7.7 and 7.8 |
| 5 | INPUT 'B' - BNC | V. § 7.7 and 7.8 |
| 6 | INPUT 'A' - BNC | V. § 7.7 and 7.8 |
| 7 | SERIAL PORT | Serial RS-232 port (associated to 'Serial' option) |
| 8 | MAIN BALANCED OUTPUT | Main XLR output, electronically balanced. An hardware bypass (via relay) connects the Input A pair to these Output XLRs in case of AC power failure or whenever the unit is unintentionally turned off. This prevents the transmission chain from any audio interruption. |
| 9 | UNBALANCED OUTPUT | This pair of PinRca connectors provide an unbalanced, stereo repetition of the output signal appearing at the XLR connectors.
An hardware bypass (via relay) connects the Input A PinRca connectors pair to these Output in case of AC power failure or whenever the unit is unintentionally turned off. This prevents the transmission chain from any audio interruption.
See also (13). |
| 10 | BALANCED INPUT | XLR input pair (electronically balanced). |

Merlin - GENERAL DESCRIPTION

- 11 UNBALANCED INPUT/OUTPUT** Depending on the button (12) selection, this pair of PinRca connectors provide an unbalanced, stereo repetition of the signal appearing at the input 'B' XLR connectors (*foldback* function, via independent buffers) or serve as unbalanced input (in place of XLR balanced one). In the latter case, only one connector may be connected at a time to avoid malfunctions.
- 12 IN/OUT SELECTION ON PIN CONNECTORS** The pair of PinRca connectors can be set as XLR-paralleled input or as 'foldback' output (i.e. it replicates the signal fed at the XLR input) accordingly to the status (pressed / released) of that button. See also (11)

7 CONFIGURATIONS

7.1 INPUT SWITCHING MODES (JUMPER SETTING)

Merlin features several input switching modes, depending on the Jumper setting on the front panel bay. All switching modes are related to the **AUTOMATIC** operating mode.

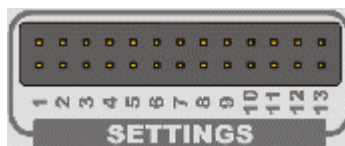

N°	Jumper PRESENT	Jumper NOT PRESENT	NOTES
J1	Left and Right channels switching is independent and done accordingly to the configuration of remaining Jumpers.	Left and Right switch in linked mode, accordingly to the configuration of remaining Jumpers.	
J2	Failure on Input A determines switching on Input B	Failure on Input A does NOT determine switching on Input B	
J3	In the event of Input A failure, it switches on Input B only if B source is present ('RATE' LEDS off).		It needs J2
J4	In the event of Input A failure, it switches on Input B (and only if B source is present, accordingly to J3 set) and stay on B even if A Input resumes.		J2 needed (J3 needed for additional Input B presence detection).
J5	In the event of Input A failure, it switches on Input B. Once switching has been done, in the event A Input resumes, it wait for B counter time (<i>timer</i> B) before switch back on A.	In the event of Input A failure, it switches on Input B. Once switching has been done, in the event A Input resumes, it wait for a time period set from P10 and P11 timers before switch back to A (see Section 7.3.2)	It must be always associated to J2, J4 and J6

Merlin - CONFIGURATIONS

J6	With B Input selected from external command (provided through 'opto' interface), in the event of B failure, Merlin switches back to A in any case (even if B switching command stays on)		
J7	Switching on B input is done only when either A Input – Left and Right channels go down.	Switching on B input is done only as soon as either A Input – Left or Right channels goes down.	Jumper J1 must be OPEN (i.e. not present)
J8	Switching back to A input is done in the event of failure of both B Input – Left & Right channels.	Switching back to A input is done as soon as B Input – Left or Right channel disappears.	Jumper J1 must be OPEN (i.e. not present)
J9	Switching on B (set) is performed in the event of lack of Sync on Video source, Left and/or Right audio failure on MPX source or MPX Pilot failure.		Reserved to 'Video' and MPX options.
J10	Switching back to A (reset) is performed in the event Sync on Video source resumes, Left and/or Right audio resumes on MPX source or MPX Pilot comes back.		Reserved to 'Video' and MPX options.
J11	Lack of Serial connection activity determines switching on B Input (set)		Reserved to 'Serial' option
J12	Resuming Serial connection activity determines switching back to A Input (set)		Reserved to 'Serial' option
J13	General Reset		Reset command is performed as soon as Jumper is inserted (it is not generated with Jumper kept closed)

7.2 SWITCHING-RELATED AUDIO LEVELS

7.2.1 'SILENCE' THRESHOLD

'Silence' threshold level is adjusted by means of THR trimmers, which are separated for A and B channels (see 4 on the front panel).

Trimmer travel is around 270°.

- When rotated anti-clockwise, threshold level is around – 33 dBu.
- When rotated clockwise, threshold level is around – 13 dBu.
- At 'twelve o'clock' position threshold is set at around – 18 dBu (**default value**)

7.3 INPUT SWITCH TIMING

7.3.1 'SILENCE' TIME

The 'silence' time duration before the Merlin switches or acts accordingly to operating mode set at Section 7.1 is adjustable by means of TIME trimmers (one for each input - see (4) on the front panel) in conjunction with Jumpers J1 - J 2 (Input A) and J3 – J 4 (Input B).

Time is calculated on the basis of 'RATE' LEDs blinking (see Front Panel view).

Actually, TIME trimmers adjust blinking rate (time interval between two consecutive flashes) while the Jumpers allow to set the total number of flashes before the Merlin switches.

If not otherwise notified, default number of blinks is 16.

Trimmers adjust flash time between 0.1 and 8 seconds.

- With trimmer rotated anticlockwise blinking time is around **0.1** seconds.
- With trimmer rotated clockwise blinking time is around **8** seconds
- **DEFAULT TIME IS AROUND 4 SECONDS** (at the middle point)

EXAMPLE

With trimmers fully clockwise rotated, switching is performed after 'silence' time of $8 \times 16 = 128$ seconds (2 minutes and 8 seconds)

With trimmers fully anti-clockwise rotated, switching is performed after 'silence' time of $0.1 \times 16 = 1,6$ seconds

Jumper J1, J2, J3 and J4 set the number of blinks (16, 64 or 256) before switching to stand-by source.

Merlin - CONFIGURATIONS

J 1, J2, J 3, J 4				
NUMBER OF BLINKS	16	256	256	64

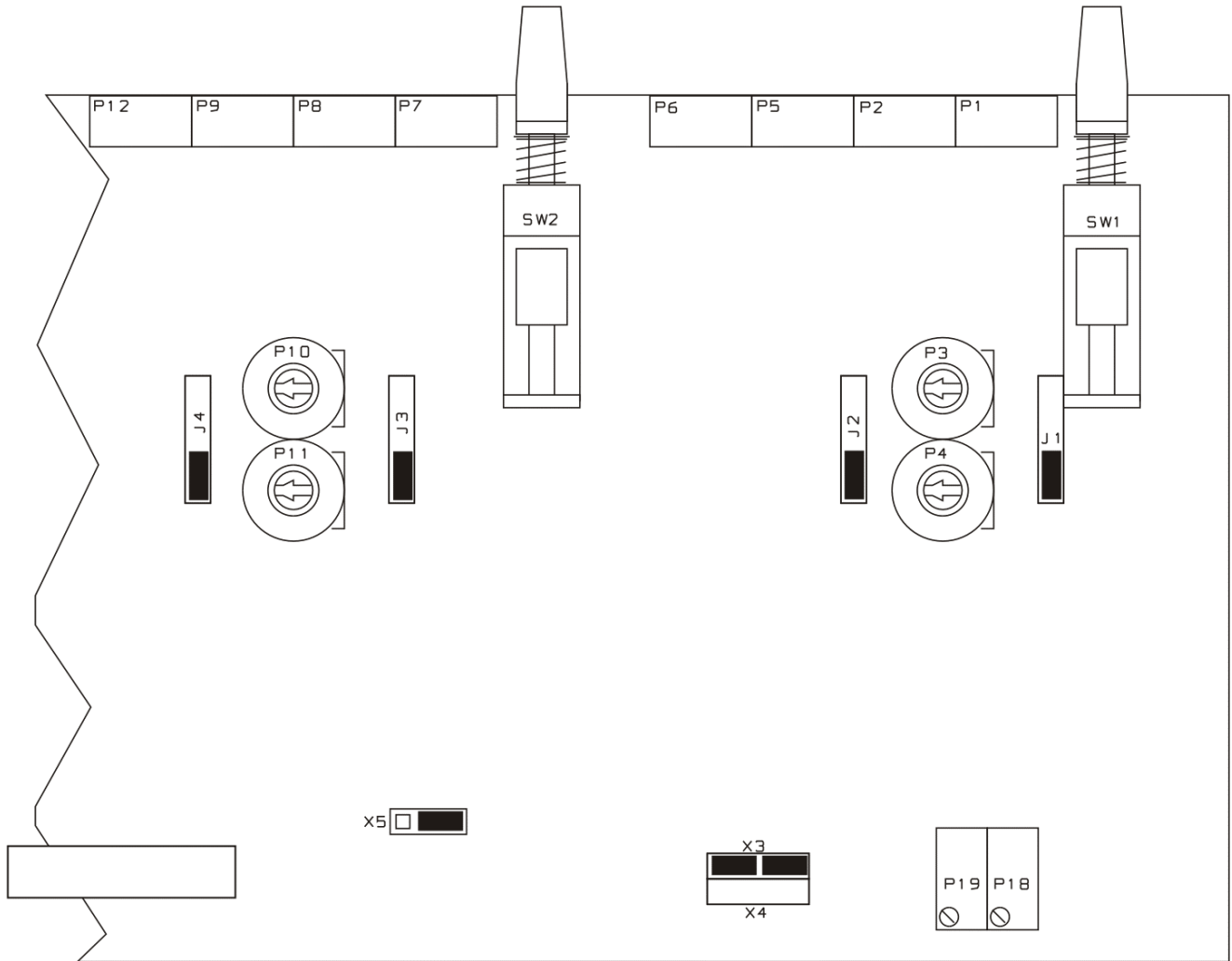

Note: counters are reset as soon as main signal comes back to working levels.

Merlin - CONFIGURATIONS

7.3.2 RECOVERY TIME

Once the Merlin has switched from Main to Stand-by input, the Main input may be kept monitored till the Main audio input resumes. Also when Main audio appears, a time ranging from 0.5 to 10 seconds may be awaited before inverse switching (from B to A) is performed.

P3 adjusts RIGHT channel time – A INPUT

P4 adjusts LEFT channel time – A INPUT

P10 adjusts RIGHT channel time – B INPUT

P11 adjusts LEFT channel time – B INPUT

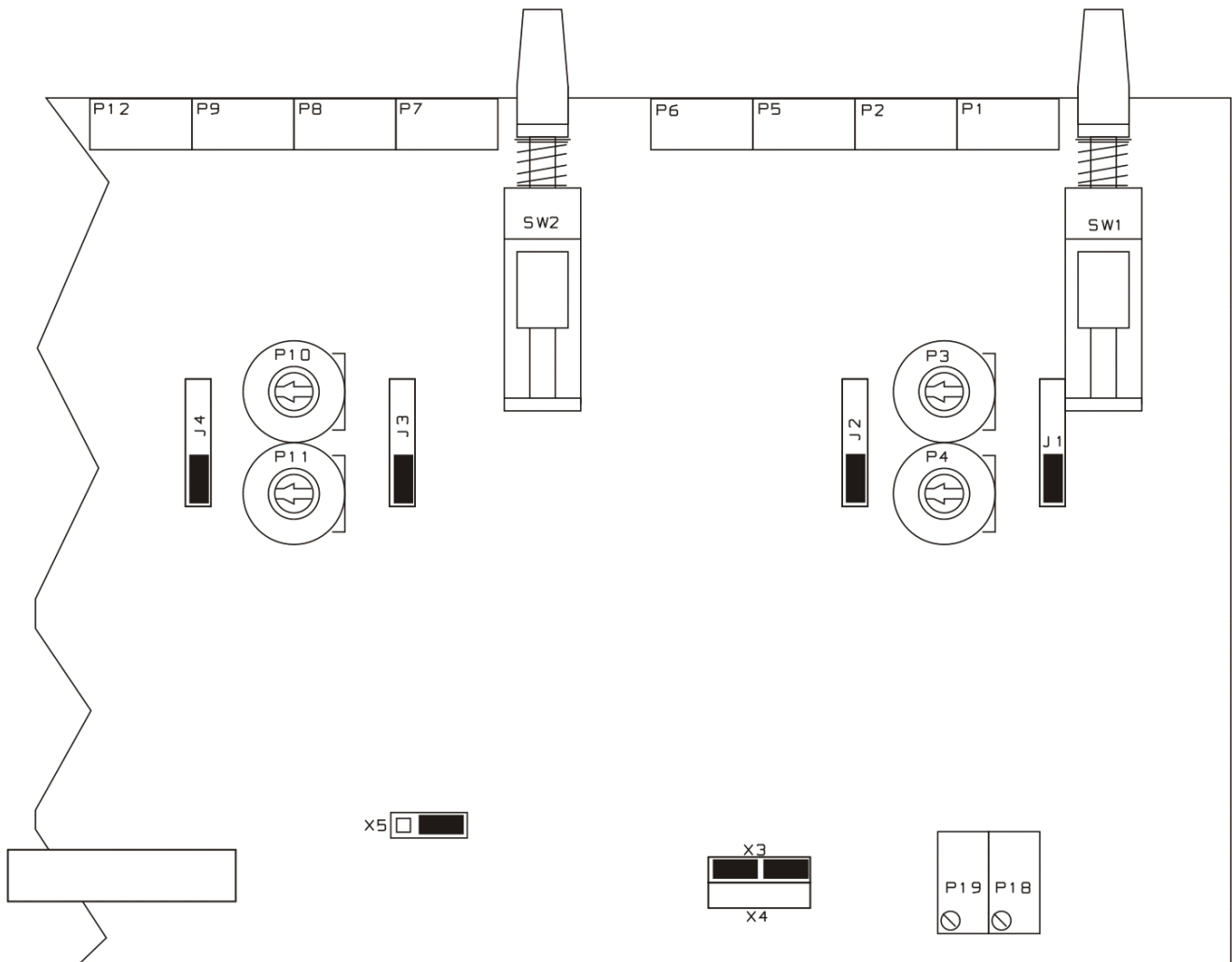

- With trimmer rotated anticlockwise time is around **10** seconds.
- With trimmer rotated anticlockwise time is around **0.5** seconds
- **DEFAULT TIME IS AROUND 2 SECONDS**

Ref also to Jumper **J5** on the front panel (Section 7.1) to set a time as long as the B counter time.



7.4 MONO / STEREO INPUT MODE

The two Inputs A and B may operate either in MONO or STEREO mode. In the MONO mode, LEFT channel is mirrored on the RIGHT channel, so that the same audio material will be available on both output channels. MONO/STEREO mode is set by **Jumper X5** (for **B input**) and **Jumper X3 and X4** (**A input**).

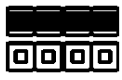
X 5		B input - LEFT channel is duplicated on RIGHT channel (MONO mode)
		B inp. - LEFT ch. is routed separately from RIGHT ch. (STEREO mode)
X 3 - X4		A input - LEFT channel is duplicated on RIGHT channel (MONO mode)
		A in. - LEFT ch. is routed separately from the RIGHT ch. (STEREO mode)

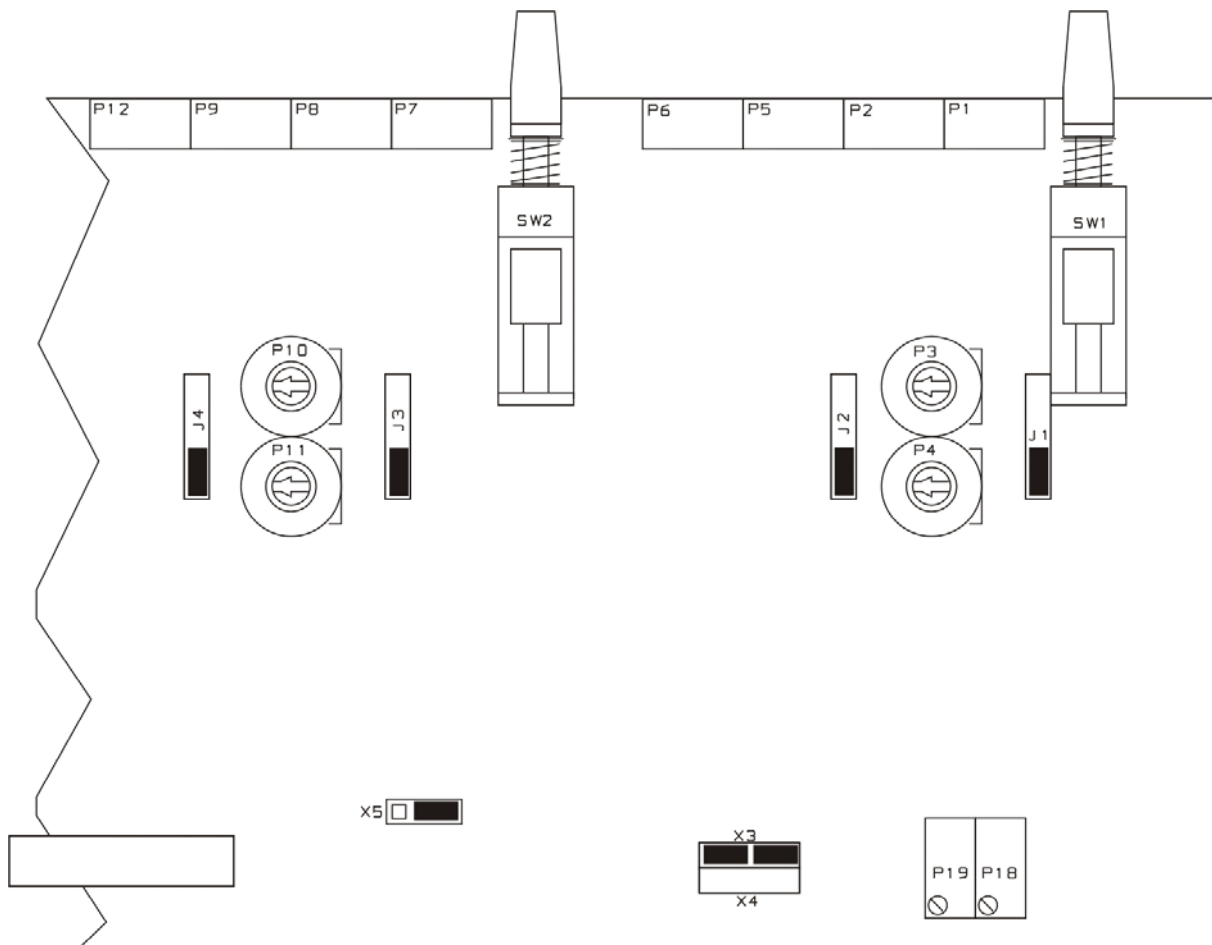

Merlin - CONFIGURATIONS

7.5 INPUT B PRE-EMPHASYS

Merlin featured a built-in 50 microsec pre-emphasys stage so that its output is made suitable for Frequency Modulated (FM) broadcast. Pre-emphasys can be associated only to B input / LEFT and/or RIGHT channels (so that ouput will be pre-emphasized when B input is routed to the output).

Pre-emphasys is associated to B input **LEFT** channel with **Jumper J8** closed.

Pre-emphasys is associated to B input **RIGHT** channel with **Jumper J10** closed.

NOTE the pre-emphasized signal will be output on both XLR and PinRca output connectors.

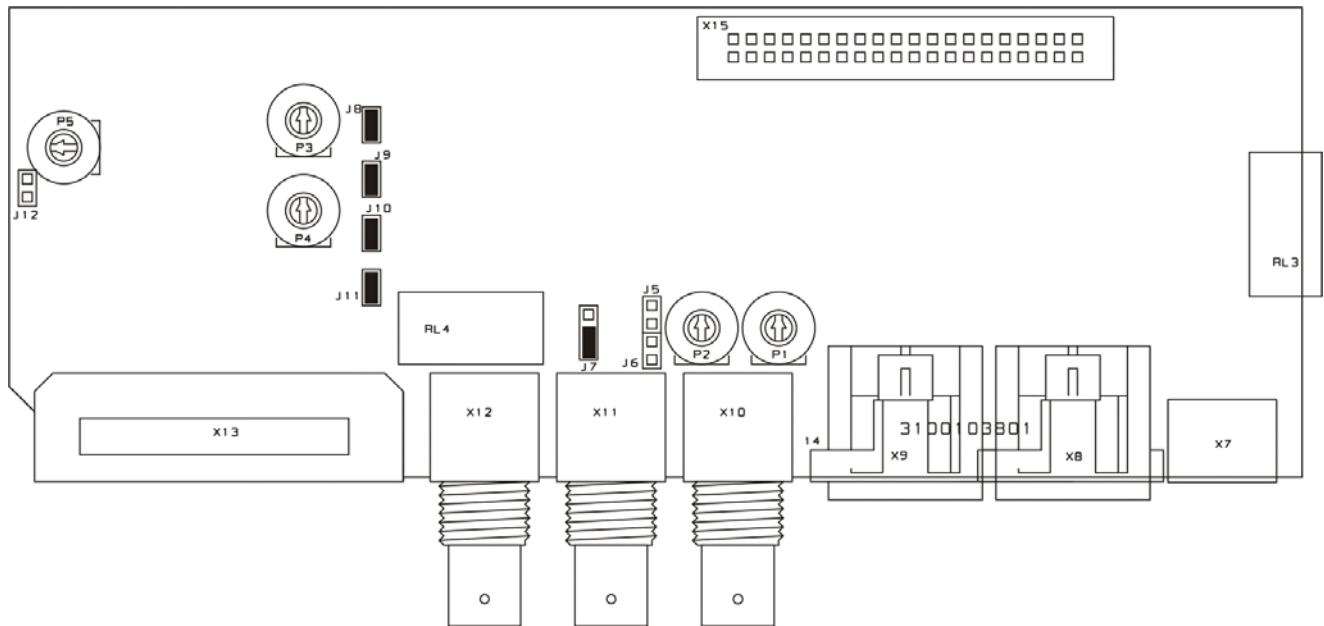

Merlin - CONFIGURATIONS

7.6 19 KHz PILOT TONE ACTIVATION

Merlin features a built-in 19 KHz oscillator (pilot) suitable for stereo-like FM broadcasting**

The Pilot Tone may be associated to B-Input only, so that when that Input is selected, the Merlin output will contain a 19 KHz pilot tone mixed into.

More precisely, J9 and J11 jumper allow to mix the Pilot Tone to (respectively) L & R Input B channels separately.

Pilot tone frequency and level can be adjusted through dedicated trimmers (see Section 8.2)

Tone Pilot is injected on B Input – Left channel with J9 closed

Tone Pilot is injected on B Input – Right channel with J11 closed

NOTE: the pilot tone-added signal will be output on both XLR and PinRca output connectors.

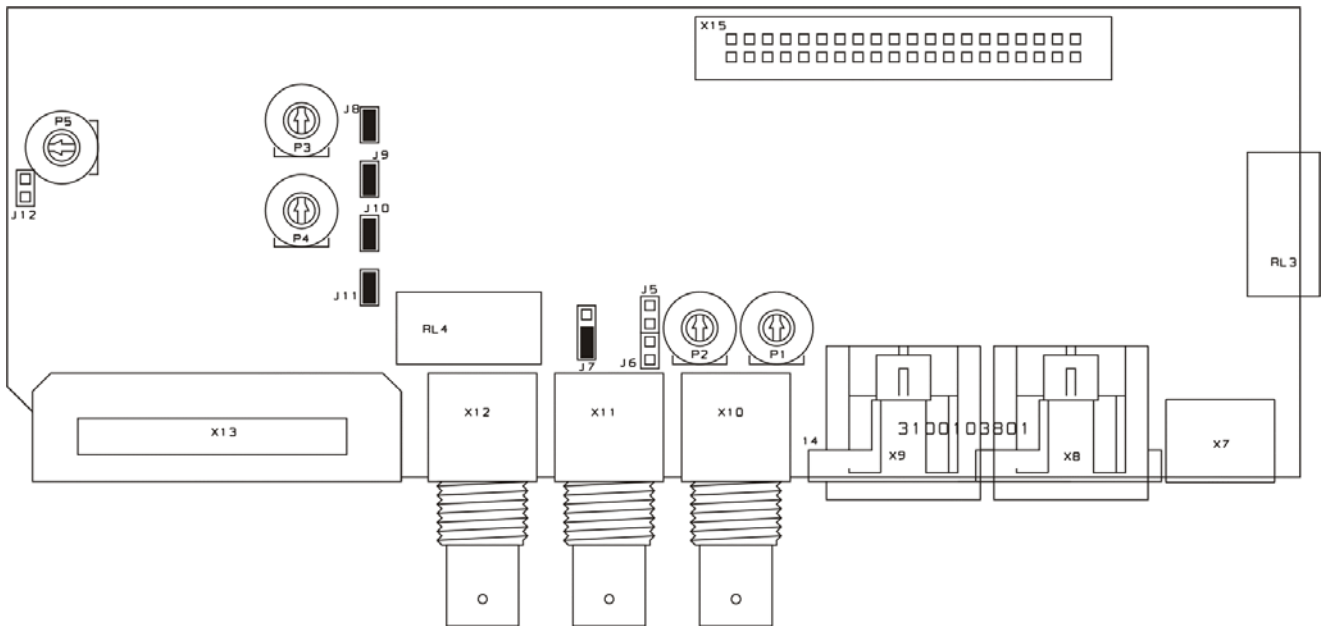

** it is not a 'true' Stereo Fm broadcasting as Merlin does not incorporate a Stereo coder. L/R sum and difference is therefore not transmitted.



7.7 INJECTION OF AN EXTERNAL SOURCE

Merlin supports injection of any external source (with frequency between 0 and 100 KHz) on input A and/or B signals. The resulting sum will be output on both PinRca and XLR output connectors. Using this facility fixed tones, RDS signals, DTMF tones may be easily summed to main audio signals. Refer also to block diagram for further details.

External injection on Merlin output is enabled by J7 Jumper in conjunction with Jumpers J5 and J6 (separated for Left and Right independent output channels).

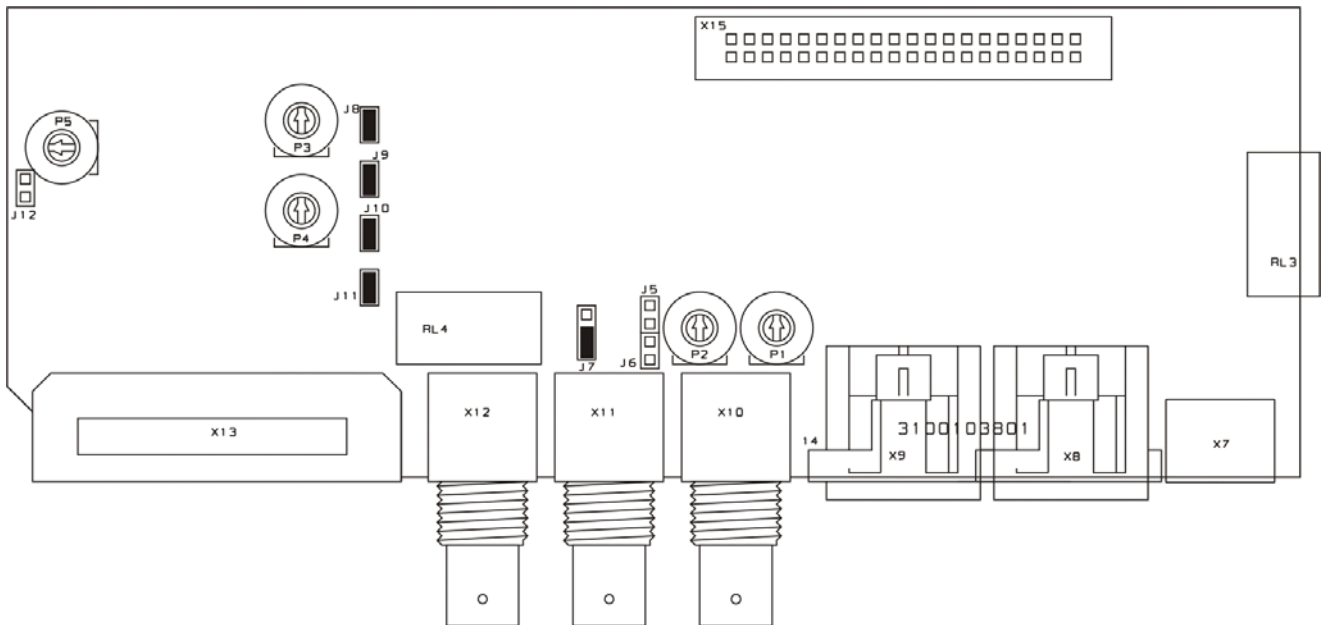
Injection levels are trimmer-adjustable (see Section 8.4)



J 7		External injection enabled
		External injection disabled (Bnc connectors are for standard switching purpose - see Section 7.8)

J 5	enables external injection on LEFT output channel	
J 6	enables external injection on RIGHT output channel	

Merlin - CONFIGURATIONS

There are THREE injection modes:

- external (injected) signal appears on Merlin output only when A INPUT is selected (MODE 1)
- external (injected) signal appears on Merlin output only when B INPUT is selected (MODE 2)
- external (injected) signal appears on Merlin output regardless of selected input (MODE 3)

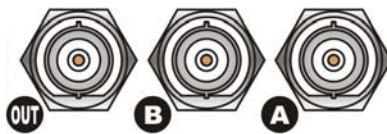

When MODE 1 is used, external signal must be injected on 'A' BNC connector

When MODE 2 is used, external signal must be injected on 'B' BNC connector

When MODE 3 is used, external signal must be injected on 'OUT' BNC connector



7.8 SWITCHING BETWEEN COAXIAL SOURCES (VIDEO, MPX, ETC)

Merlin features 3 BNC connectors which, if properly jumper-set, allows switching between coaxial sources (such as MPX composite FM signals, Video sources, etc).

Switching is accomplished by Relays and it follows the same rules as switching on XLR/PinRca connectors.

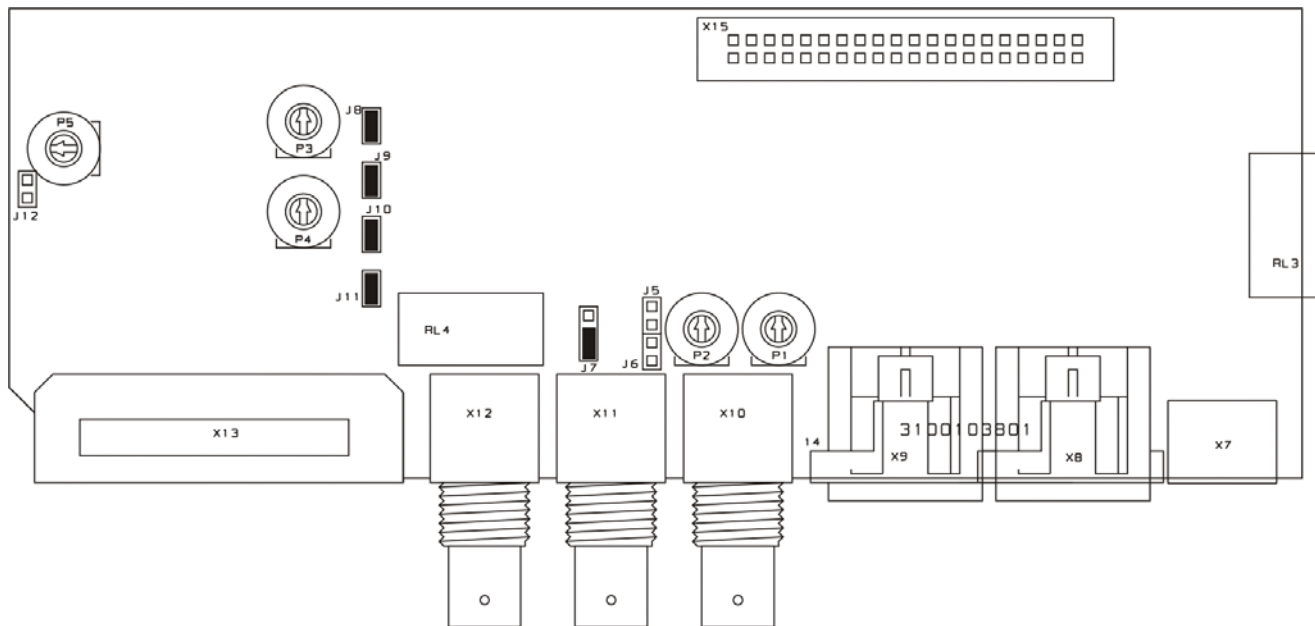
Jumper J7 is used to choose BNC connector purpose (standard switching purpose or injection of external signals).



J 7		External injection enabled
		External injection disabled (Bnc connectors are for standard switching purpose - see Section 7.8)

8 ADJUSTEMENTS

8.1 REFERENCE TONE LEVEL AND FREQUENCY

The level of internal Reference Tone (internal 1 KHz oscillator, enabled from front panel switch – see (6)) may be adjusted via **P13** trimmer. By default, level is set at 0 dBm. Tone frequency is adjusted by means of **P20** trimmer (default value is 1 KHz).

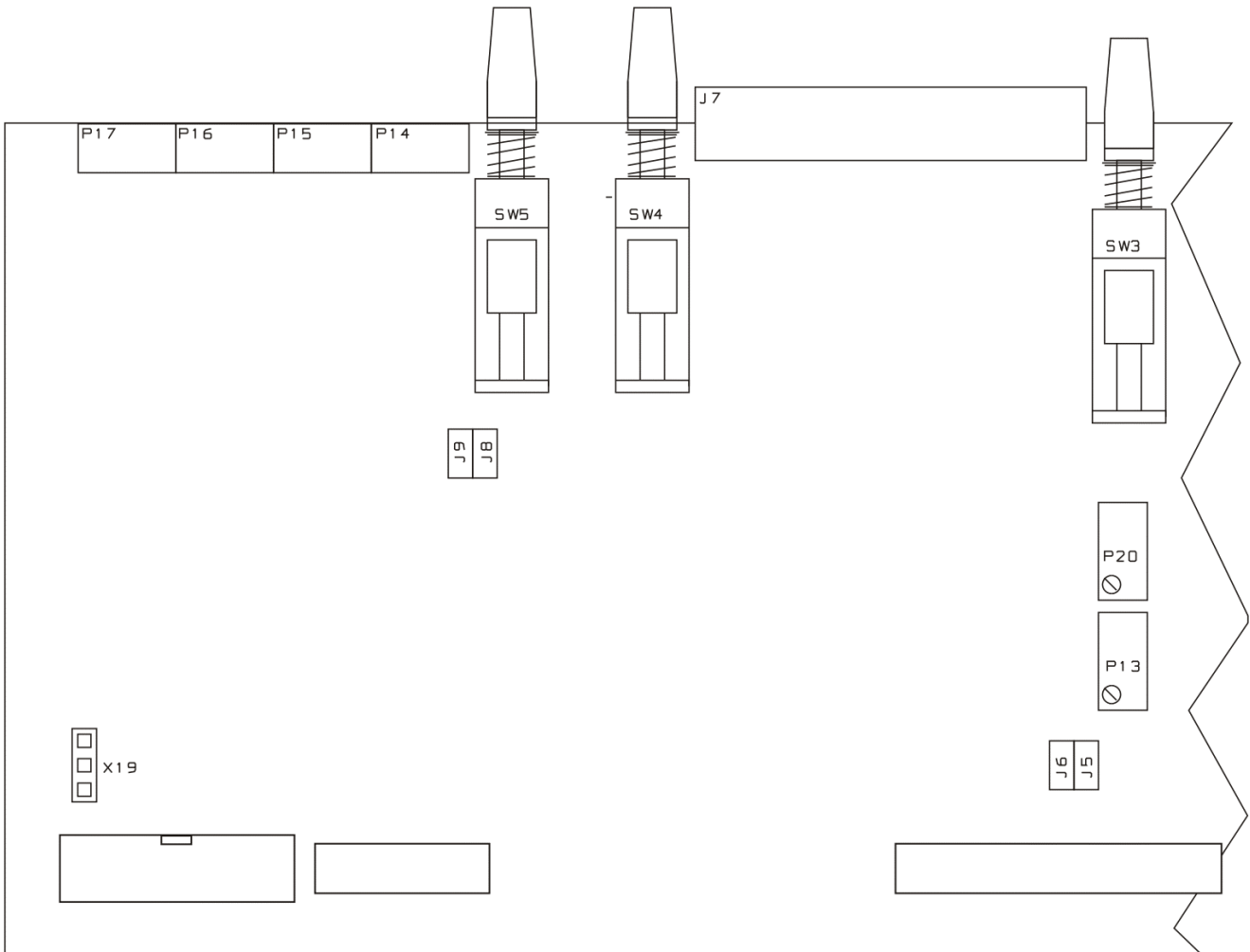

8.2 PILOT TONE FREQUENCY

Pilot Tone frequency (ref also to § 7.6) is adjustable via trimmer **P5** located on the rear board. Default value is **19 KHz**.

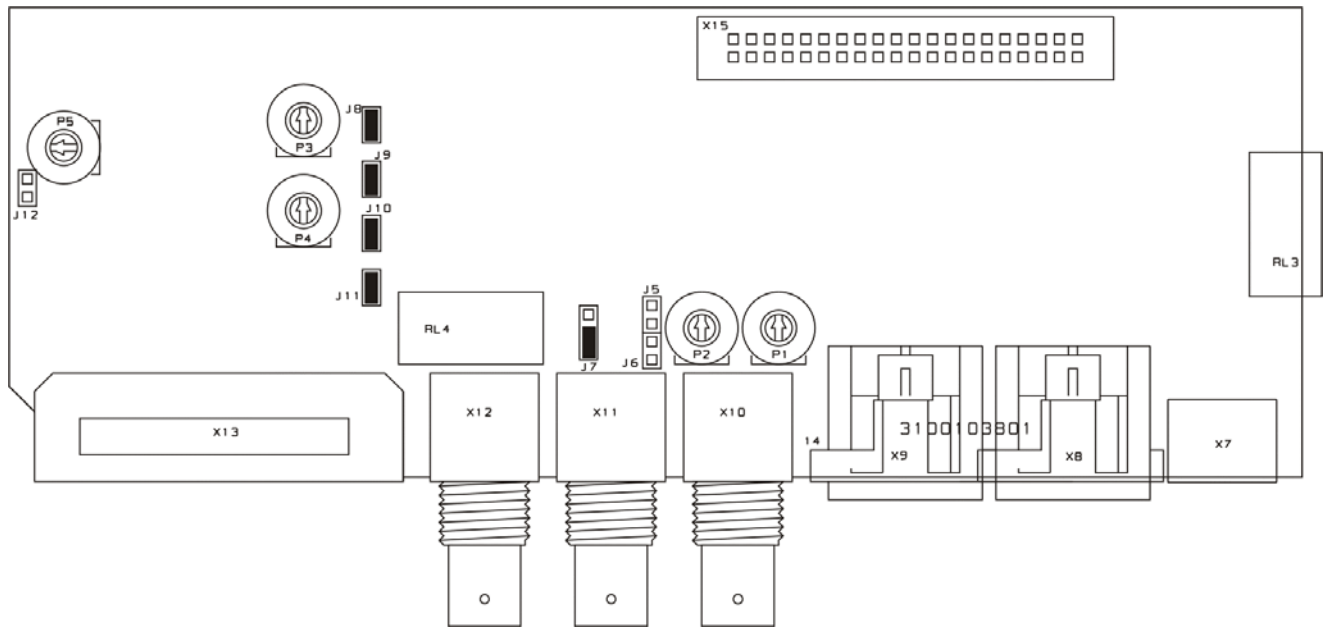

8.3 PILOT TONE INJECTION LEVEL ON B-RIGHT & B-LEFT CHANNELS

Pilot tone auto-generated by Merlin and injected on B-input / Channels L & R (see Section 7.6) is adjusted from trimmers P4 and P3.

P4 adjusts injection level on Right channel

P3 adjusts injection level on Left channel

Default level is – 20 dB for both channels

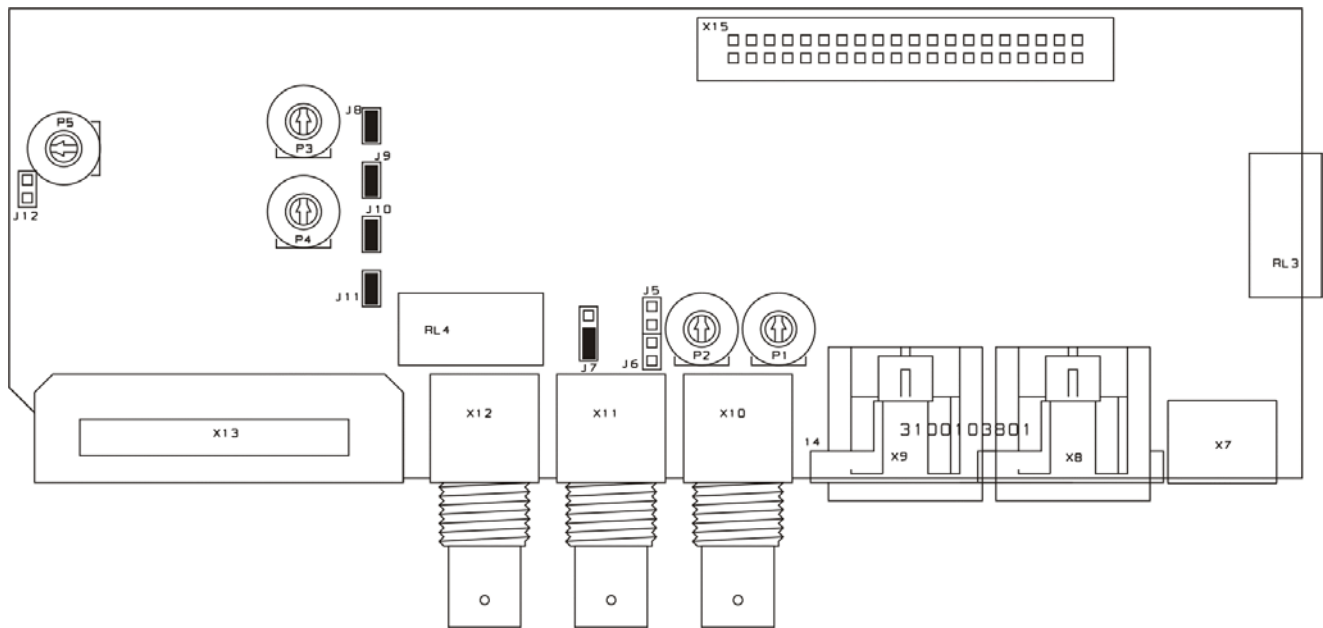

8.4 LEVEL OF INJECTION OF AN EXTERNAL SIGNAL ON L&R OUTPUT CHANNELS

External signal injected from BNC 'A', 'B' or 'OUT' connectors (see Section 7.7) is summed to A and/or B inputs with a level adjusted through P1 and P2 trimmers located on the rear board.

P2 adjusts injection level on Right OUTPUT channel

P1 adjusts injection level on Left OUTPUT channel

Default level is 0 dB for both channels

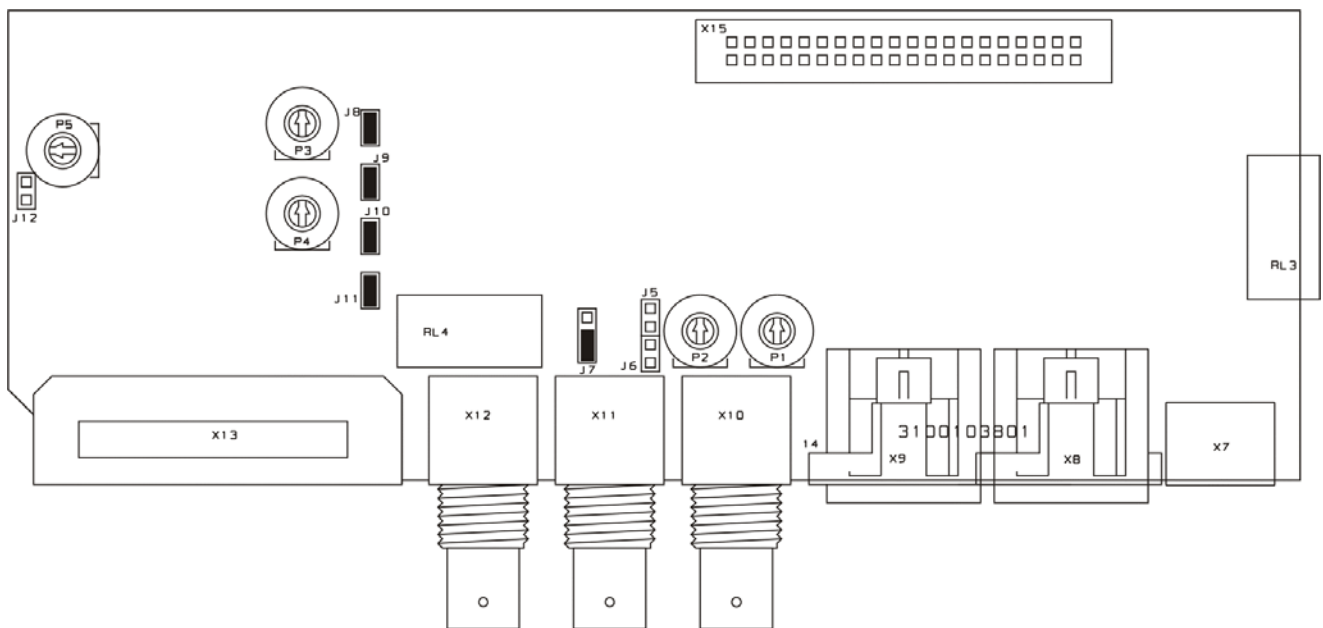

9 AUDIO AND REMOTE INTERFACE DESCRIPTION

9.1 AUDIO CONNECTIONS

9.1.1 INPUTS

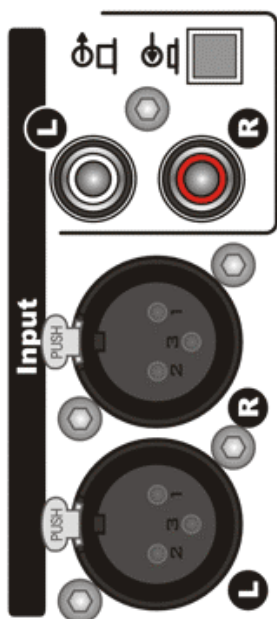

The equipment features electronically balanced XLR female inputs (line level).

- Pin 1 Ground
- Pin 2 Signal (+)
- Pin 3 Return (-)

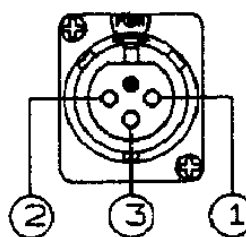

If any balanced connection is possible, please use PinRca connectors (having set them as input connectors through the associated In/OUT switchers – see next Section) or connect the cold pole (Pin 3) to the ground (Pin 1) on XLR connectors.

Factory preset input impedance is 10 kΩ. Input impedance of 600 Ω is also available, simply setting jumpers **J1**, **J2**, **J3** and **J4** on the rear board (see following section).

9.1.2 INPUT IMPEDANCE SETTING

INPUT A	J1 (Right Ch.), J2 (Left Ch.)		INPUT IMPED. 10 KOHM
			INPUT IMPED. 600 OHM
INPUT B	J3 (Right Ch.), J4 (Left Ch.)		INPUT IMPED. 10 KOHM
			INPUT IMPED. 600 OHM

Merlin - AUDIO AND REMOTE INTERFACE DESCRIPTION

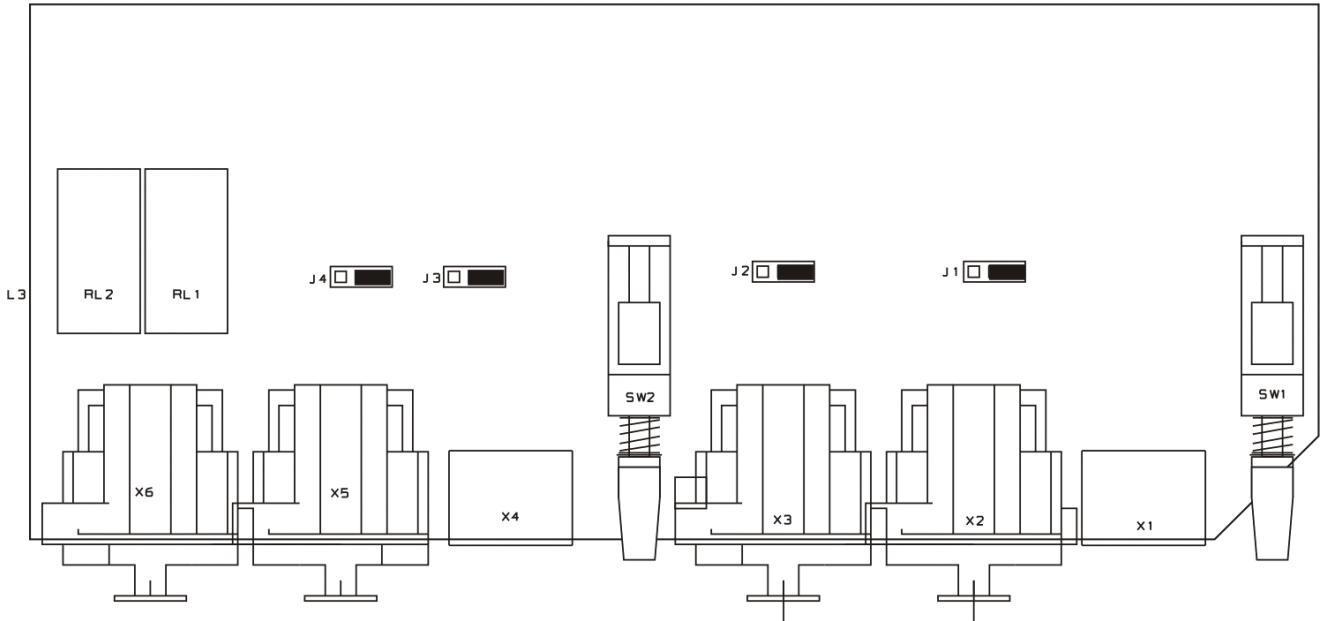

9.1.3 PIN RCA CONNECTOR ASSIGNMENT

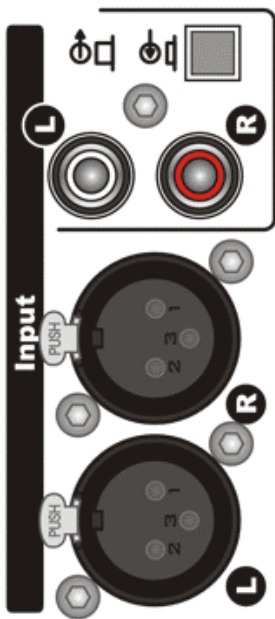

PinRca connectors associated to XLR input connectors may be configured as fold-back output of balanced inputs (i.e. the replicate the input signal in unbalanced mode) or as alternative, unbalanced inputs.

A proper button is provided for this aim, close to PinRca connectors (see picture)

9.1.4 OUTPUT

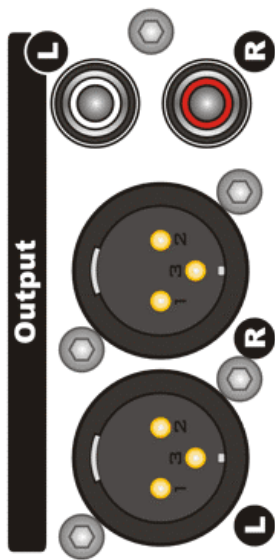

The equipment features XLR analog outputs electronically balanced by high-quality buffers, capable of withstanding even low-impedance loads (600Ω), with levels of up to +20 dBu.

Pin 1 Ground
Pin 2 Signal (+)
Pin 3 Return (-)

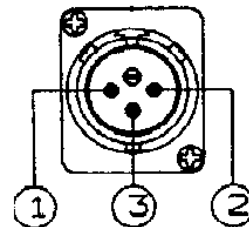

In case of unbalanced connections, please use PinRca connectors

Output impedance is fix, at around 50 Ohm.

9.2 'OPTO'INTERFACE

D-Type, 25 Pin connector located on the rear panel GPI/O and tally associated to the equipment status.

Interface inputs and outputs are optoinsulated.

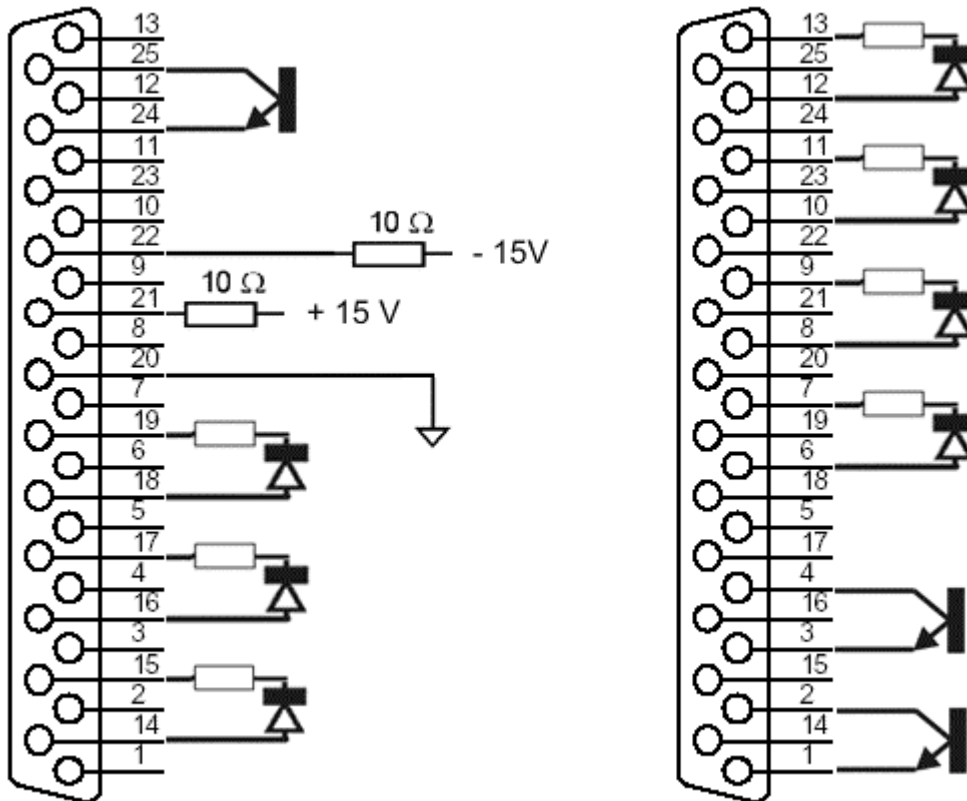

Two tensions (+ / - 15 Volt) are provided on pins 22 and 21 through 10 Ohm resistors for general use.

To polarize in a proper way the input photodiodes use one of the following suggestion:

- if an external + 5 VDC is available, feed it directly to the photodiodes (f.i., to control MIX mode from remote, provide the positive rail to pin 14 and Ground to pin 15, as shown on the next page table).
- In no external voltages are available, use the Merlin's supplied 15 VDC to polarize photodiodes through a 2000 Ohm, ¼ Watt resistor.

Please notice, the interface supports either MOMENTARY (pins from 6 to 13) or LATCHED (pins from 16 to 19) commands.

In the first mode, an impulse provided to Pin 9 and 8 causes switching from Input A to Input B (RIGHT channel), while an impulse applied to Pins 6 and 7 forces opposite switching.

When a permanent (latched) command is applied, f.i. , across Pins 16 and 17, B-input / LEFT channel will stay selected as long as the command is on.

Merlin - AUDIO AND REMOTE INTERFACE DESCRIPTION

NOTE switching remote control is achievable ONLY while Merlin is in AUTO mode.

PIN	DESCRIPTION	DIRECTION
25	Collector of photocoupler – 'Manual' mode engaged	OUT
24	Emitter of photocoupler – 'Manual' mode engaged	OUT
23	Not connected	/
22	- 15 VDC (through 10 Ohm protection resistor)	OUT
21	+ 15 V DC (through 10 Ohm protection resistor)	OUT
20	Ground	/
19	Cathode of photocoupler – permanent switching command from A to B / Right channel	IN
18	Anode of photocoupler- permanent switching command from A to B / Right channel	IN
17	Cathode of photocoupler – permanent switching command from A to B / Left channel	IN
16	Anode of photocoupler- permanent switching command from A to B / Left channel	IN
15	Cathode of photocoupler – command enabling mix between inputs	IN
14	Anode of photocoupler- command enabling mix between inputs	IN
13	Cathode of photocoupler – momentary switching command from A to B / Left channel	IN
12	Anode of photocoupler – momentary switching command from A to B / Left channel	IN
11	Cathode of photocoupler – momentary switching command from B to A / Left channel	IN
10	Anode of photocoupler – momentary switching command from B to A / Left channel	IN
9	Cathode of photocoupler – momentary switching command from A to B / Right channel	IN
8	Anode of photocoupler – momentary switching command from A to B / Right channel	IN
7	Cathode of photocoupler – momentary switching command from B to A / Right channel	IN
6	Anode of photocoupler – momentary switching command from B to A / Right channel	IN
5	Not connected	/
4	Collector of photocoupler – Input B / Left channel activated	OUT
3	Emitter of photocoupler – Input B / Left channel activated	OUT
2	Collector of photocoupler – Input B / Right channel activated	OUT
1	Emitter of photocoupler – Input B / Right channel activated	OUT

9.3 SPECIAL SWITCHING FEATURES

When switching is remotely controlled from the OPTO interface, two pairs of Jumpers (J8,J9 and J5,J6) allows to enable audio detecting on B Input so that, in the event no audio is detected, Merlin will switch back to A even if switching command is kept active.

In particular, with **J8** and **J9** closed, when providing a PERMANENT switching command through Pins 19 to 16, in the event no audio is present on B, Merlin will switch back to A as soon as the silence time expires.

With **J5** and **J6** closed, when providing a momentary switching command from A to B, in the event no audio is present on B, Merlin will switch back to A as soon as the silence time expires.

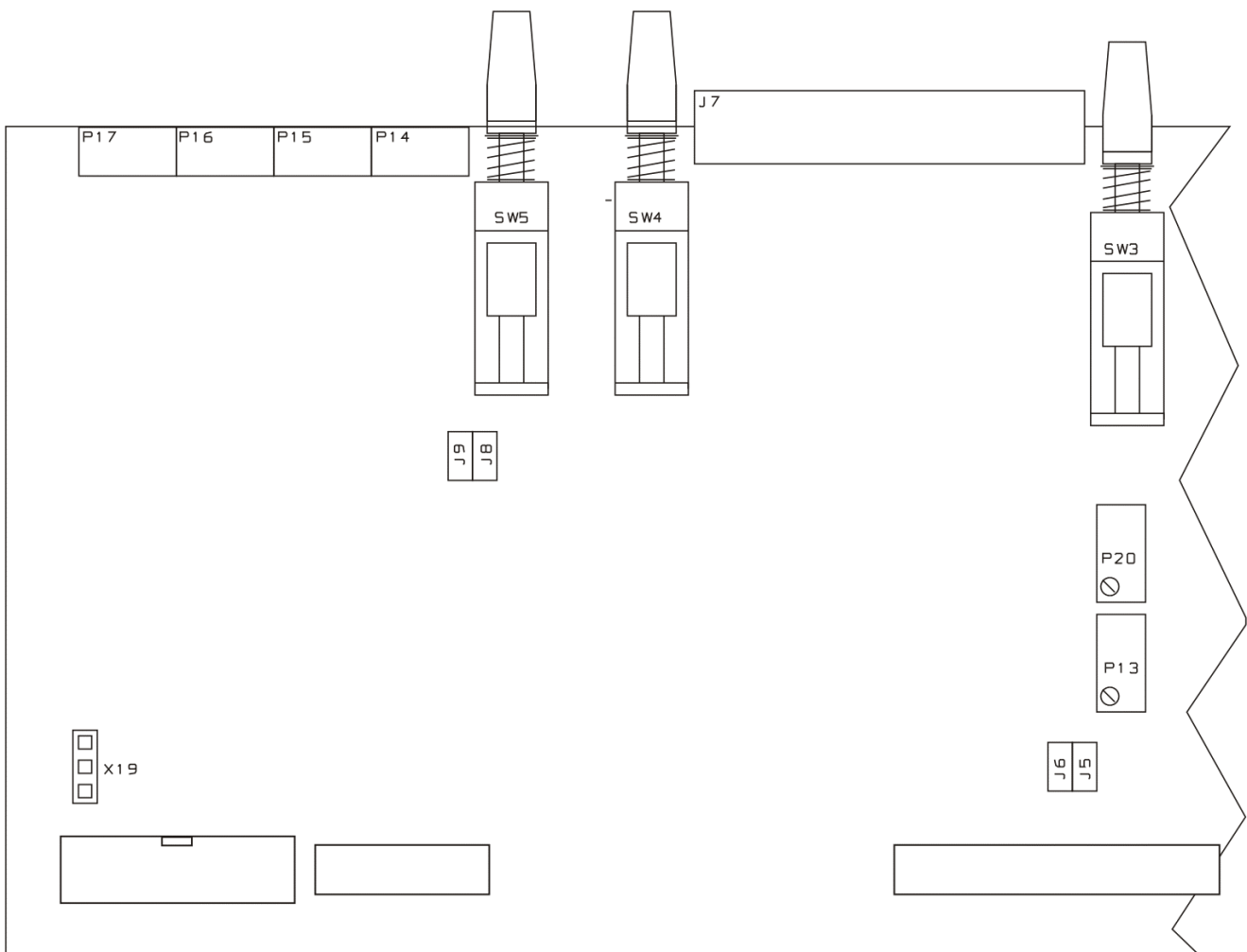

9.4 'RELAY' INTERFACE (OPTIONAL)

As already notified, the 'Relay' interface is available as an option.

It contains 5 Relays, 2 of which (Relay 4 and Relay 5, double-way type) are permanently associated to B input switching and 3 are user-assignable.

Connector pin-out is as in the following table:

PIN	DESCRIPTION	
25	RELAY 5 – WAY 1 <i>(related to Right channel switching)</i>	Common
24		NC
23		NO
22		- 15 Vdc
21		+ 15 Vdc
20		GND
19	RELAY 5 – WAY 2 <i>(related to Right channel switching)</i>	NO
18		NC
17		Common
16	RELAY 1	Common
15		NC
14		NO
13	RELAY 4 – WAY 1 <i>(related to Left channel switching)</i>	NO
12		NC
11		Common
10	RELAY 4 – WAY 2 <i>(related to Left channel switching)</i>	Common
9		NC
8		NO
7	RELAY 3	NO
6		NC
5		Common
4	RELAY 2	NO
3		NC
2		Common
1		GND

Merlin - AUDIO AND REMOTE INTERFACE DESCRIPTION

9.4.1 Relay 1, Relay 2 and Relay 3 assignment

Three relays R1, R2, R3 are completely Jumper configurable by the user. Jumpers are located on Relay board. They (such as Relays 4 and 5) may be set in momentary or latched mode, accordingly to the associated jumpers J2, J3, J4, J5 and J6 (see Section 9.4.3).

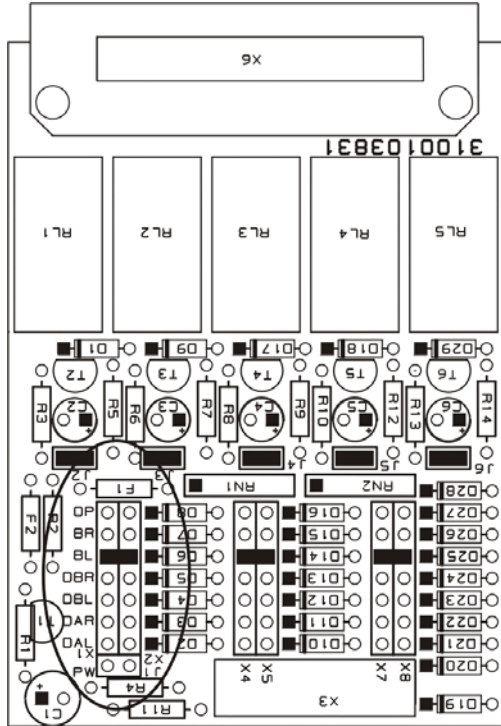

JUMPERS X1-X2 (associated to Relay1)

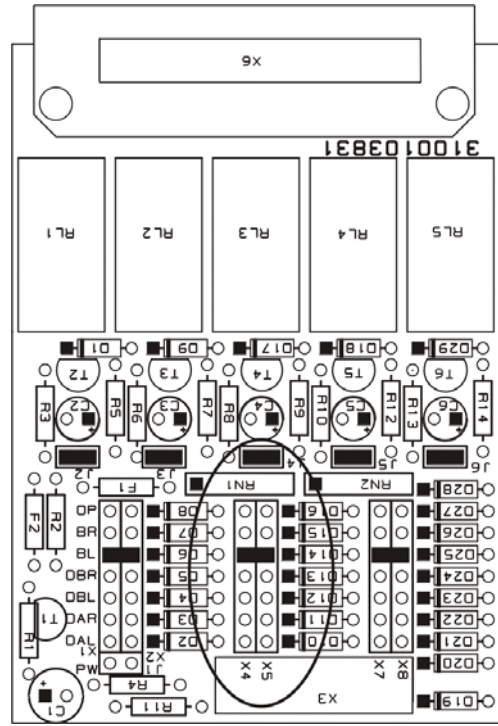



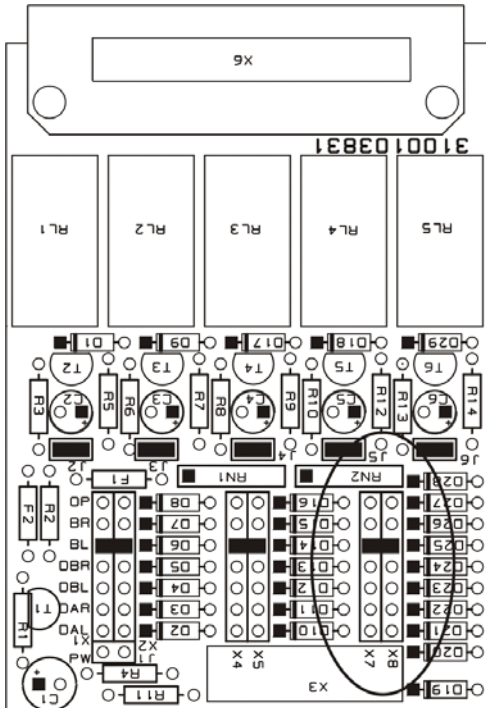







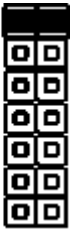























JUMPERS X4-X5 (associated to Relay2)



JUMPERS X7-X8 (associated to Relay3)

Merlin - AUDIO AND REMOTE INTERFACE DESCRIPTION

The following table shows Jumper assignments (multiple choices are possible).

<p>X1-X2</p> <p>X4-X5</p> <p>X7-X8</p>	<p>OP </p> <p>BR </p> <p>BL </p> <p>DBR </p> <p>DBL </p> <p>DAR </p> <p>DAL </p>	<p>Selected relays toggle on proper commands coming from installed optional boards (OP) (video detector, serial detector, etc). In the event no optional boards are installed, the Relay can be associated to Auto/Man button switching (so that Relay with OP jumper close will reflect Merlin AUTO/MAN status). To do this, place X19 jumper on the front board in the AUTO / MAN position (see Front Board Layout here below).</p>
<p>X1-X2</p> <p>X4-X5</p> <p>X7-X8</p>	<p>OP </p> <p>BR </p> <p>BL </p> <p>DBR </p> <p>DBL </p> <p>DAR </p> <p>DAL </p>	<p>Selected relays toggle when B input – Right channel is activated.</p>
<p>X1-X2</p> <p>X4-X5</p> <p>X7-X8</p>	<p>OP </p> <p>BR </p> <p>BL </p> <p>DBR </p> <p>DBL </p> <p>DAR </p> <p>DAL </p>	<p>Selected relays toggle when B input – Left channel is activated.</p>
<p>X1-X2</p> <p>X4-X5</p> <p>X7-X8</p>	<p>OP </p> <p>BR </p> <p>BL </p> <p>DBR </p> <p>DBL </p> <p>DAR </p> <p>DAL </p>	<p>Selected relays toggle when under-threshold signal (B input – Right channel) is detected.</p>
<p>X1-X2</p> <p>X4-X5</p> <p>X7-X8</p>	<p>OP </p> <p>BR </p> <p>BL </p> <p>DBR </p> <p>DBL </p> <p>DAR </p> <p>DAL </p>	<p>Selected relays toggle when under-threshold signal (B input – Left channel) is detected.</p>

Merlin - AUDIO AND REMOTE INTERFACE DESCRIPTION

<p>X1-X2</p> <p>X4-X5</p> <p>X7-X8</p>	<p>OP </p> <p>BR </p> <p>BL </p> <p>DBR </p> <p>DBL </p> <p>DAR </p> <p>DAL </p>	<p>Selected relays toggle when under-threshold signal (A input – Right channel) is detected.</p>
<p>X1-X2</p> <p>X4-X5</p> <p>X7-X8</p>	<p>OP </p> <p>BR </p> <p>BL </p> <p>DBR </p> <p>DBL </p> <p>DAR </p> <p>DAL </p>	<p>Selected relays toggle when under-threshold signal (A input – Left channel) is detected.</p>

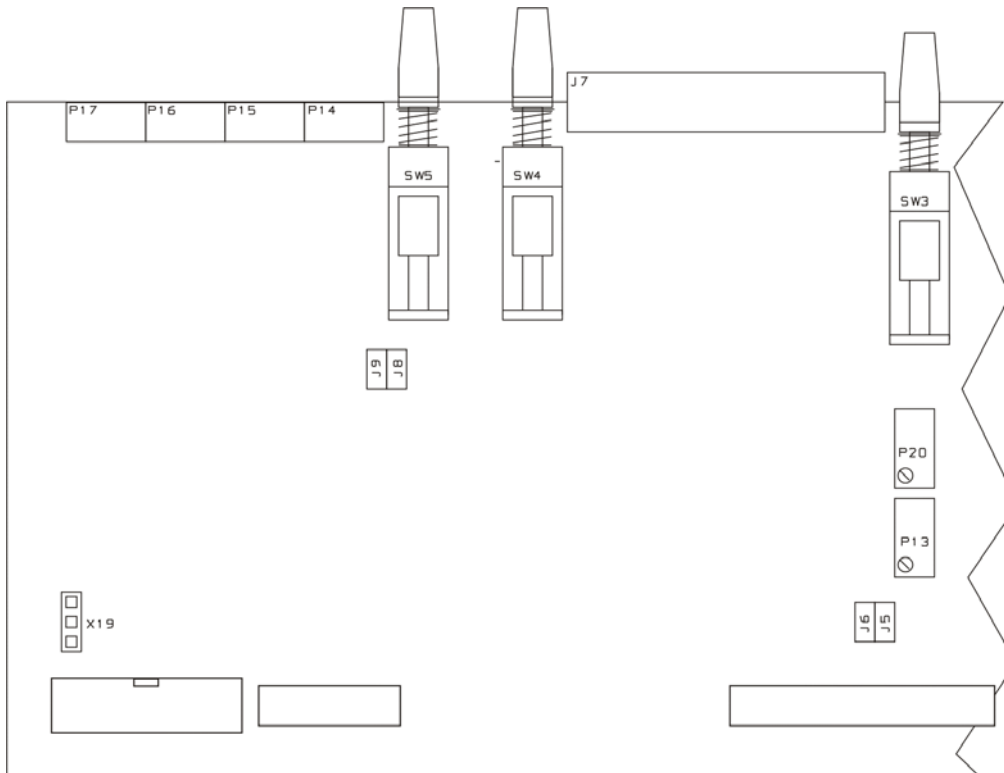

<p>X19</p>	<p>Relays 1 to 5 are driven by Optional boards commands (Video, Serial, MPX) when set in OP mode</p>
	<p>AUTO/MAN status is signaled through Relays 1 to 5 when set in OP mode with no Optional board (Video, Serial, MPX) present</p>

Merlin - AUDIO AND REMOTE INTERFACE DESCRIPTION

9.4.2 Relay 1 assignment to Dc POWER failure

Relay 1 only may be used – when properly configured – for signaling of power failure on one or both rails of internal Power Supply (+/- 15 Volt).

Relay 1 will stay close (NC – normally Close) as long as power is regularly provided. As soon as one of both of voltage rails will be down, Relay opens.

To enable Relay 1 as internal Voltage power detector, POWER jumper on the Relay board must be closed (see Figure).

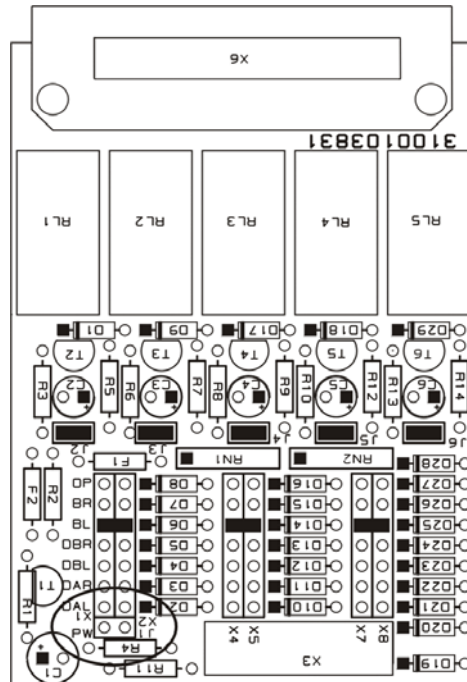

Merlin - AUDIO AND REMOTE INTERFACE DESCRIPTION

9.4.3 Momentary or Latched Relay setting

Relays from 1 to 5 may be set in momentary or latched mode, accordingly to the associated jumpers J2, J3, J4, J5 and J6.

With jumper closed, Relay is set as Latched
With Jumper open, Relay is set as Momentary

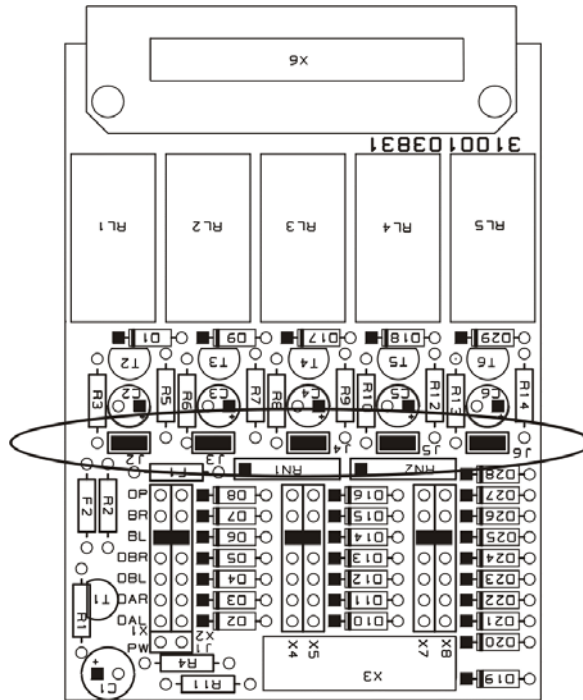

J2 (first from left) is associated to Relay 1
J3 (second from left) is associated to Relay 2
J4 (third from left) is associated to Relay 3
J5 (fourth from left) is associated to Relay 4
J6 (at the right end) is associated to Relay 5

10 VCA OPTION

VCA option board supports two operating modes:

- 1) **CROSSFADE**: it allows to perform a smooth transition between A and B (from A to B and viceversa) source .
- 2) **AUTOFADER**: as soon as B input appears, A input is faded out .

Transition times and duration are all user-configurable.

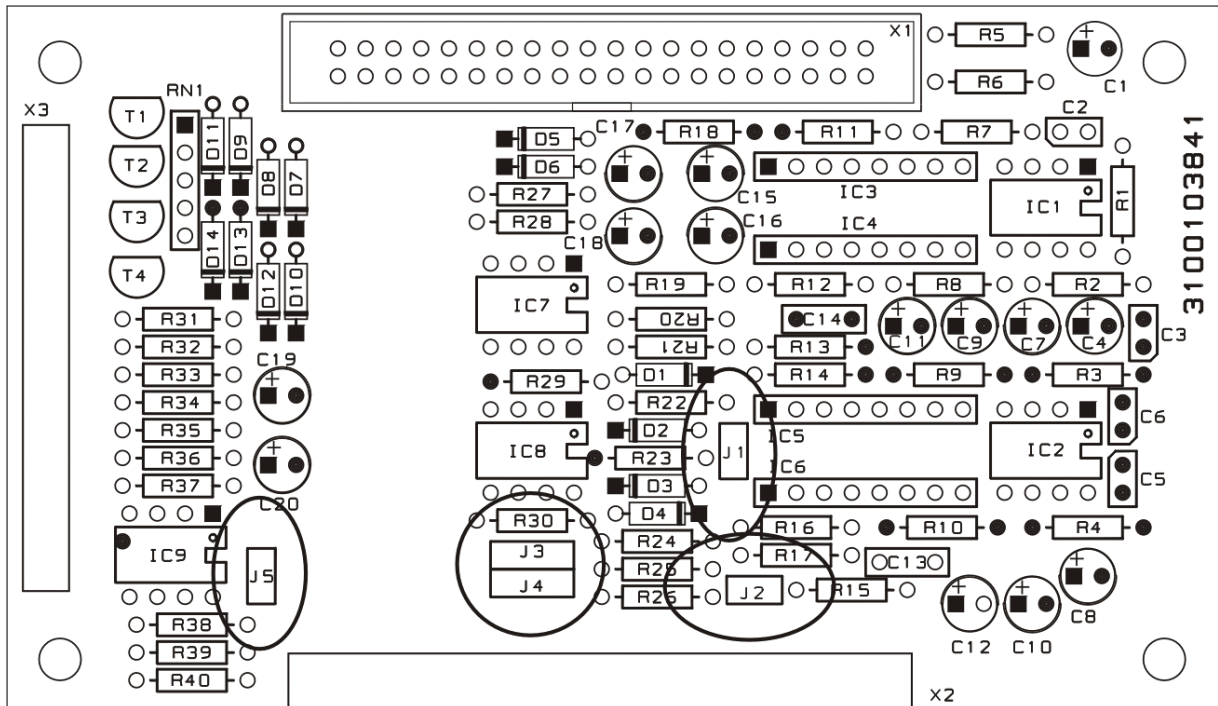

Jumper summary table:

J1	<input type="checkbox"/>	NO COUPLING
	<input checked="" type="checkbox"/>	COUPLING Left+Right (Input A)
J2	<input type="checkbox"/>	AUTOFADER OFF
	<input checked="" type="checkbox"/>	AUTOFADER ON
J3	<input checked="" type="checkbox"/>	VCA BY-PASS (B-LEFT)
	<input type="checkbox"/>	VCA THROUGH (B-LEFT)
J4	<input checked="" type="checkbox"/>	VCA BY-PASS (B-RIGHT)
	<input type="checkbox"/>	VCA THROUGH (B-RIGHT)
J5	<input type="checkbox"/>	NO MIX
	<input checked="" type="checkbox"/>	MIX (A+B)

10.1 CROSSFADE MODE

Crossfade transition mode from A to B and back is performed with the following jumper setting:

J1	Set on COUPLING mode
J2	Absent
J3	Set on VCA THROUGH mode
J4	Set on VCA THROUGH mode
J5	Set on MIX mode

Transition times are controlled by Trimmers **T1**, **T2**, **T3** and **T4** located on the front panel (see Section 6.1). Transition slopes may be set as in the following picture:

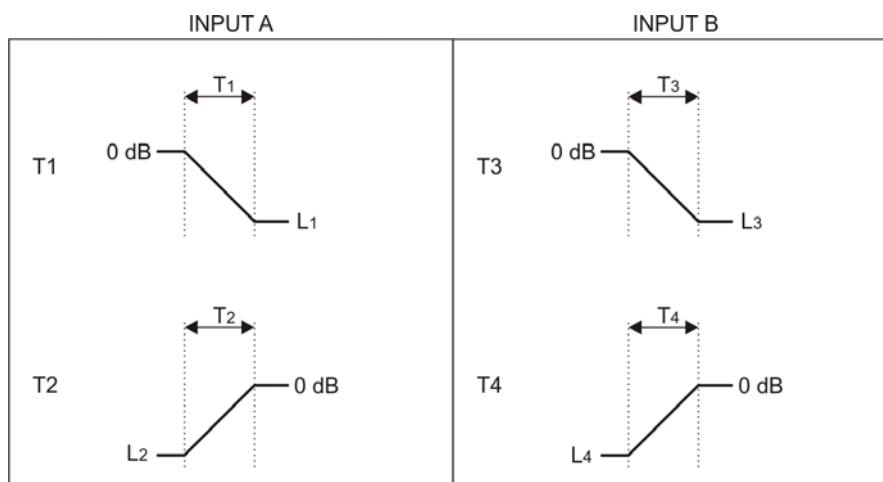

where:

	MIN	MAX
T1	0.1	3
T2	2	5
T3	0.1	4
T4	0.1	3

and levels **L1**, **L2**, **L3** and **L4** are around **- 80 dB**.

10.2 AUTOFADER MODE

Autofader transition mode is performed with the following jumper setting:

J1	Set on COUPLING mode
J2	Present (AUTOFADER ON)
J3	Set on VCA BYPASS mode
J4	Set on VCA BYPASS mode
J5	Set on MIX mode

Merlin - BLOCK DIAGRAM

11 BLOCK DIAGRAM

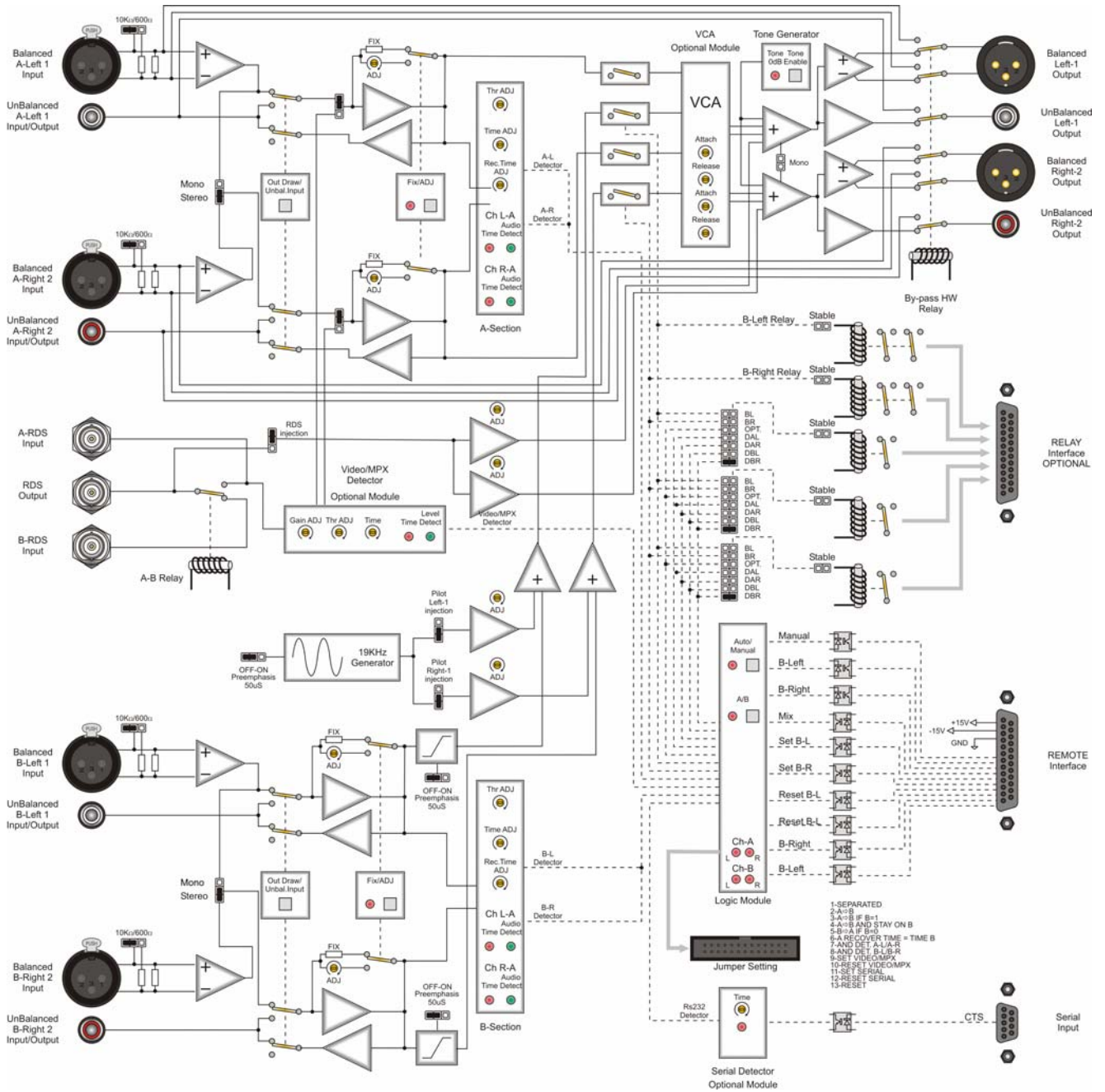

12 TECHNICAL SPECIFICATIONS

GENERAL FEATURES

Weight	~ 3.5 Kg
Dimensions	1 Rack Unit (484 x 351 x 44 mm)

AUDIO INPUTS (1 and 2)

Connector Type	XLR female el. bal.
Max Input Level	+ 20 dBu
Level adjust	+ / - 10 dB
Impedance	10 K Ω

'DRAW' OUTPUTS / UNBAL INPUTS

Connector Type	Pin RCA
Level	The same as XLR inputs and output
Purpose	Unbal. mirror of XLR inputs and output

AUDIO DETECTING STAGE

Threshold	Adjustable, - 20 dB ÷ - 60 dB
Detection delay	From a few seconds to a few minutes,

AC Main	110 / 220 V _{AC} , 50 – 60 Hz
Consumption	10 VA

AUDIO OUTPUT

Connector Type	XLR male el. bal.
Max Output Level	+ 20 dBu
Output Levels	0, + 6 dBu (internal setting)
Impedance	100 Ω

PERFORMANCE

Linearity	\pm 0,1 dB 10 Hz ÷ 100 kHz
Noise	< - 90 dB (DIN Noise)
Crosstalk L to R	< - 80 dB @ 1 kHz

REMOTE CONTROL INTERFACE

Connector type	DB 25 p female
Devices	5 relays, 10 photocouplers